

Europa Express

THE PUBBER: Gary L. Coughlan

4614 Martha Cole Lane, Memphis, Tennessee 38118
USA (901)-362-7206

Oh, it's so nice to be back with my regular typewriter again. After typing the last EE, it broke down twice more and the typewriter repairers finally fixed it right. So this is one thing that I'm thankful for this Thanksgiving Season. The other is good friends.

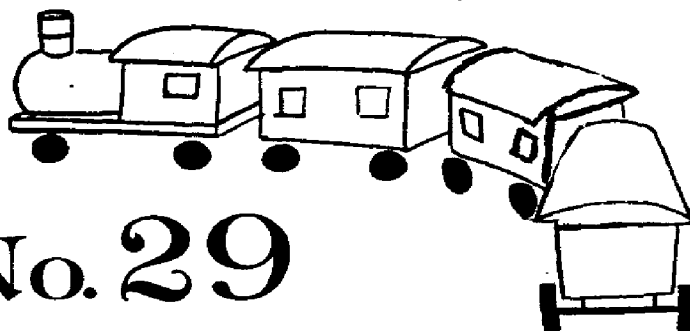

No. 29

17 N O V E M B E R 1983

Well, never again will I go on vacation and have to GM 5 games and put out an issue of this zine within four days of returning! When I got back, I went to the post office to get the mail that they had been holding for me. I still haven't read it all but if you're interested in totals, it was: 1 cassette tape, 55 letters and postcards concerning Diplomacy, 46 zines and 118 pieces of regular mail (bills, magazines and assorted junk mail). If I owe you a letter (and I'm sure I do), please be patient and understanding.

Another surprise was that the Post Office no longer delivers to my mail box. Now I'm part of a cluster mailbox and it's two blocks away from my home. I don't like it but you really have no recourse.

About my Europe trip: I'll either be putting a report on it in the December EE or in a special EE extra. I had a great time and want to thank all the Europeans who took such time and trouble to make us feel at home. My trailor is your trailor!

I've also got some surprising phone calls lately. Before I left for Europe, Pete Tamlyn, pubber of Britain's The Acolyte, called me to see exactly when I would be in London so they could set up a meeting at the Lamb (Joan Extrom, don't plead ignorance--see page 36!); then C-G Spare of Finland called me (He was in New York). C-G's letters and comments are well-known to EE subbers. Then one of my old Korea Army buddies, David MacIntosh, called me out of the blue, and maybe intends to join this hobby. Dave's wife Sooki can make sure my Korean is correct within EE!

If Korean in EE and other things confuse you, it's all explained on page 10. In addition to the subzines, MASS MURDERS and MOS EISLEY SPACEPORT, EE is proud to welcome a new addition to the family, THE BEHOLDER by John Kelley. TB was a full-fledged zine until 1980 when John folded it due to school. Now he's back as a subzine and it begins on page 42.

I'm still ~~totally caught up~~ not totally caught up, so here are two more addresses. (The rest are on page 26): John Leeder: 224 20th Avenue NW, Calgary, Alberta T2M 1C2 CANADA..... Dave and Sooki MacIntosh: Rt. #6, Apt 5, Connersville, Indiana 47331 USA.

If you haven't voted in the Peoples Diplomacy Auction yet (see page 30), it's probably too late. EE has two games up for bid there, Judy Winsome has her pigtail, Mike Mills is offering fake zines from the past (For a fake zine of now, see page 43), and many other items. All money raised goes to the hobby services. One of the items I put up keeps getting smaller--the Dick Martin-Julie Martin Dictionary. Remember what made it distinctive was the pages containing "alcoholic" and "drunkard" were ripped out because Dick and Julie say these are totally different words meaning totally different things. With this dictionary, you're never embarrassed about explaining the non-existent differences! Now the pages containing "crooked" and "dishonest" are also ripped out because these words, used in reference to GMing, are also apparently different in the eyes of the Martin Morality Squad. Learn Martinese?

DIPLOMACY is a registered trademark for a game invented by Allan B. Calhamer and copyrighted by The Avalon Hill Company.

Dear Larry, see page 30. Will be at
Dat Con. Larry

THIS ISSUE'S CONTENTS:

A Boxful of Mail.....	1	SEAWOLF.....	19
Bully For Billy!	2	The Biggest Zine Ever	20
No Kinky Stuff!.....	3	MASS MURDERS....Spring 1905.....	21
Drug-crazed Frakos?	4	Royal Coffee Drinking	26
Sheep-dipping in Bolivia?.....	5	MASS MURDERS....Fall 1905.....	27
A Wave of Writing Freaks	6	Last Chance for PDO Auction!	30
Badminton Beginnings.....	7	It Started With Bum.....	31
2,000 Different Games	8	MOS EISLEY SPACEPORT	32
Preference For Perfect Products...9		A 5' 8" Weedy Wimp?.....	35
All About EE	10	Snuffed At Waterloo, Then Kursk	36
WINDSOR.....	11	Post Office Problems.....	37
ALSACE-LORRAINE	13	Orwellian Morals	38
HOUSE OF BOURBON.....	15	Sleazy? A Renegade?.....	39
Picture Contest!!!	16	CARTOONS!!	40
RHINO.....	17	THE BEHOLDER.....	42
A Finley Frog Joke	18	Focus On Fakes!	43

DIPSCRIPTION TIME! Each issue of **EE**, Pat Hart of South Carolina ~~Adopted~~ honors one of you (and YOU could be next) with a personalized Dipscription--a word coined by Pat. Pat does this based on what he reads about you in **EE** and in other zines. Bill Highfield, pubber of The Modern Patriot and well-known for his intense patriotism and being in Navy ROTC and for being in love with Alex Lord, comes under Pat's scrutiny this issue. Take it away Pat!

NAME: William Highfield
NICKNAME: The modern patriot
HOME: Any naval base
BIRTHDATE: A military secret
BIRTHSIGN: Uncle Sam Wants You

SEX: Military personnel only
HAIR: Every twelve weeks
EYES: Straight ahead
LOOKS: Honed

NOTED FOR: Staunch Reagan supporter
AMBITION: Secretary of the Navy

TURN-ON: U.S. Navy
TURN-OFF: Any other navy

FAVORITE MOVIE: Midway
FAVORITE TV SHOW: McHale's Navy

FAVORITE VICE: Red Man Chewing tobacco
FAVORITE DRUG: Caffeine

FAVORITE SONG: In the Navy (Village People)
FAVORITE CHARITY: NROTC

FAVORITE PET: Carrier pigeon
FAVORITE FOOD: Anything canned

IDOL PAST: Admiral Rickover
IDOL PRESENT: Alex Lord

COLLECTS: Communist war games

FAVORITE PHRASE: It's not a job, it's an adventure

FAVORITE POEM: -----William Highfield is one of the few,
Who stands up for you know who,
One day soon he'll be a pilot,
Omigod! Ain't that a riot?



Woody Allen made a movie called Love And Death. You don't have to go to that much trouble--just be a MalMBERGER, what other zines call standbys. You are only used for one time and you get 2 **EEs** added to your sub now and 4 more when you complete an assignment. Players already in **EE** games cannot be MalMBERGERS. The 30 MalMBERGERS are: Ieapo Stabo, Peter Ansoff, Steve Arnawoodian, Doug Beyerlein, Jim Burgess, Ken Corbin, Don Del Grande, Rich Delzer, Mike Ehli, Mark Frueh, Richard Gee, Steve Heinowski, Nelson Heintzman, Bill Highfield, Hauke Jansen, Matt Kazur, Mark Keller, Pierre Kotschoubey, Mark Larzelere, Dustin Laurence, Mark Luedi, John MacFarlane, Tom Mainardi, John Morris, Bob Osuch, Jane Proskin, Clark Reynolds, Don Williams, Don E. Williams and James Woodson. Thank you all for being here, ready to help!

I'm back in the saddle again and puttin' out the zine. And don't think it hasn't been a little rough after being away from writing, games and reading zines for 3 weeks, ha ha. Europe was great (what did you expect me to say?!) and my report on it will probably be in the December EE. If not there, it will be in an "EE Extra" before the New Year. Are y'all ready for Big Brother?!

Since I went to Europe and have met many European hobbyists who were only letters before, I thought this issue we would look at articles (and some I made into articles) that compare the hobbies in different countries. I figure all of us are familiar with our own hobby in our own country so we can use that basis to view the hobby as it exists in other countries through some eyes of people who have seen zines from other countries.

The first two articles were both printed in the British zine Denver Glont, issue 20. Cathy Cunning, pubber of Seattle's Cathy's Ramblings, wrote her views to DG's editor, Glover Rogerson who then added his own impressions. Within Cathy's article, the comments in double parentheses (()) are by Glover, who happens to be Cathy's British idol. Remember that both articles were being read by and written for a British audience. And Cathy's article was entitled.....

THE JOYS OF THE AMERICAN HOBBY

---by Cathy Cunning

So like are you saying what is an American doing in the sacred pages of Denver Glont? I would ask myself that, not thinking that I am worthy enough to grace these pages, but my idol--the one and only Glover Rogerson--asked me to do an article on the American hobby. Actually, it was Philly's [Philly is to Glover as Kathy is to John Caruso here in North America] suggestion to give the proper credit where it is due. Although I would do anything that Glover asked, and when he said "please" I was honoured, but when he said "pretty please", tears of joy ran down my face as I stumbled to the nearest piece of paper and started my task--to tell about the wonderful world of the American Hobby.

The first big difference between the American and the British Hobby is the fact that it is in America. The second big difference is that there are very few British types in the American hobby. Except for the Canucks who a six one way and a half dozen the other, and no one wants to claim them. So much for the basic differences.

Next to the games. The Number one game in America is straight old fashioned Diplomacy--none of this kinky variant stuff. The rules are different too. Stand-bys are used and the Winter/Spring and Summer/Fall seasons go together. Press seems to be used more than in Britain. I'm currently playing in one game which has five to seven pages of press--the Mass Murders game that Glover mentioned. ((Europa Express-subzine)) I feel press makes the game more interesting.

There are some zines that offer other games besides Diplomacy, but they are few in number. Maybe a total of some ten zines out of the sixty or so American zines available--I'm only guessing though and I'm talking about games besides Diplomacy and its variants.

As for the zines themselves, there are a great deal of 'ware-house' type zines. These are zines that run games only, and have maybe a page of editor's comments--if any. The 'chat-zines' that Britain is so famous for are rare things in the States. Of the zines Glover has mentioned: Europa Express and Voice of Doom are the 'chat' zines. North Sealth West George and Thirty Miles of Bad Road are more middle-of-the-road zines and quite wierd. Raging Main is more of a ware-house zine, but I only saw issue one. ((continued on page 4))

Next is why the American hobby is so damn serious [Glover asked this question]

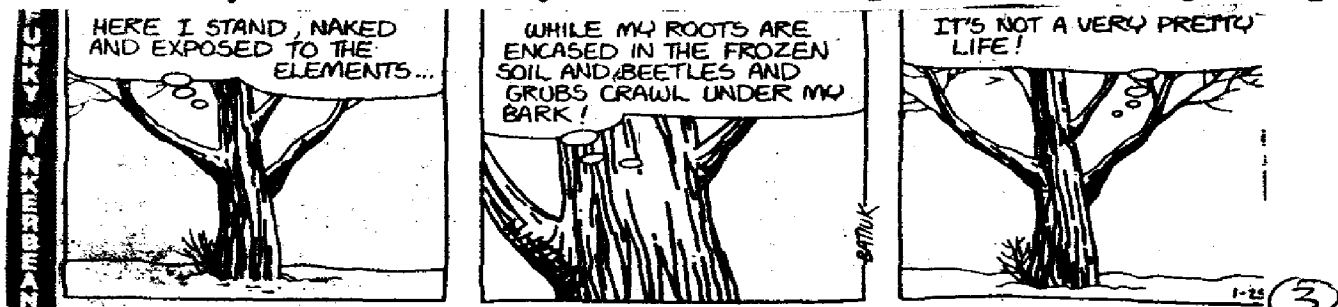

--well, we're not you know--I mean I'm not anyways. ((I'd never have guessed...)). Little Billinness [Simon Billinness, pubber of 20 Years On, which lists information on zines all over the world. The North American equivalent is Roy Henricks' Zine Register] asked me about the hard-headedness of our Dip hobby, and I agreed with him on some points. There is a certain lack of the FRPing [Fantasy Role Playing] crowd, not a total lack--I mean, I'm a FRPer--but much more so than in Britain. As I said before, the first game is Diplomacy and the second is Diplomacy variants and then war boardgames and then the FRPing types.

Well, that was a boring bit, wasn't it? Let's have some fun! How about the hobby meets and cons, as we call them. This is when a group of hardcore liars travel thousands of miles to find out who is the best liar! I've only been to a few and one was a tournament, and me the only female. Yes, they raped me, but they thought I was cute, so they let me live on with one centre countries--thanks guys! Seriously, I didn't do too bad. I came out with middle standing, and won "Best Italy". Well, someone had to win it, didn't they? Take heed, younger but not wiser Rogerson.

Where was I? Oh yes, cons--some drinking and just talking, but lots of games and hobby talk between games. Playing FTF [Face-To-Face] is a rare thing for most of us. Remember the distance factor. I'm traveling 3000 miles to go to Dip-Con this year! Now that's rough!

Well out of room as it is. This should leave Glover with a good space to fill. I've failed my idol again! sob sob."

[[And then Glover Rogerson replied.....]]

"The thesis that all Americans are wierd drug-crazed frakos--woops freakos gathers strength. Myself, i [Glover always uses the lower case] suspect that LSD [He means the drug not the Texas zine!] is to blame, but i could be wrong. Well, i do have a space, so i'll rabbit about the U.S. scene as well.

Picking up a U.S. (and i'll include Canadian) zine is a strange experience. As Cathy says, the very arrangement of the games is completely different; to the U.K. mind, the Spring move/Summer retreat split seems strange. It had never crossed my mind that people might do it in some other way; in both Voice of Doom and Europa Express the retreats and build seasons are often completely separated--again an idea i'd never considered.

From a small sample, U.S. editors and players seem to be politically more to the 'right' than in the U.K.; not surprising, given the general tenor of the country. It makes for very interesting reading; certainly: the RED THREAT is a very real to many of these people--a recent letter in Voice of Doom from Greg Ellis is wonderful. "We should support whichever government best serves the United States interests", which Bruce Linsey [the pubber of VOD] agrees with. Well, fine, somewhat obvious, and quite close to genuine right-wing anarchism.

From the viewpoint of the third world (or at least my reading of a large part of it) United States interests seem to be preoccupied with maintaining their standard of living at others' expense. Well, fine, somewhat predictable, if a little lacking in an existential concern for humanity. They (the Americans, says he becoming sweeping) don't seem to realise that their statements justify exactly that which they fight; and that to a lot of people, it's somewhat obscene to see a rich country screw a poor one--which is why most of the concerned intelligensia support any form of anti-American guerrilla action.

Mr. Ellis is at least coherent; the US also produces what seems to me to be terminal cases of capitalism run rampant; i think of Billy Highfield "If patriotism is a sickness then I'm terminally ill!" (It is, you probably are), Michalski & whoever it was wrote a wonderful article in Europa Express about how to deal with "Terrorists" [David Perlmutter in EE #16]

Ah, well. To get back to the hobby, the differences that one finds over here are exaggerated, it seems to me--perhaps it's a reflection of the more open garrulous Yank character, but the hobby is full of exclamation marks, and cutting comments and feuds. Boy, you thought Pete Tاملن [pubber of The Acolyte and the loser in Cathy Cunning's "Beast" contest to Brian Dolton] could upset folks; these guys do it every issue--more, they go out of their way to stir trouble!

There are the more happy-go-lucky sorts as well; Steve Hutton [pubs Canada's No Fixed Address] & Mark Luedl [pubs 30 Miles of Bad Road] seem pleasantly eccentric.

((Continued on page 5))

(4)

GLOVER ROGERSON'S ARTICLE...continued from page 4 .

[pubs north south west coast]

while Terry Tallman is intriguingly wierd. Ah, strange country though, strange country; so serious about so much, and so convinced in what they say.

Try a North American zine; not very expensive, and guaranteed to provide you with a different perspective of life; the comprehension of the American view (if there is such a thing) seems useful to me--but then i'd say that about most any nation you care to name. (The Albanian view of vivisection? The impact of sheep dipping in Bolivia? Could this be a new trend in international understanding....)''

[I share Cathy's love of the British hobby and I've received roughly 20 British zines out of about 50 total, for almost 3 years now, including 9 out of their poll-rated top ten zines. Even so, I don't feel I am an expert on the British hobby or qualified to say that the British hobby is thus and so. BUT. One thing which has continually amused me about the British editors is when they give their views of the North American hobby based on the 2, 3 or 4 zines they receive when there are about 60 zines as Cathy mentions. But to give them their due, they know much more about us than we know about them. Only 3 of us (Mark Berch, Cathy Cunning and myself) voted in the UK Zine poll this last year. And do YOU know the name of the British zine which has won as the Number One zine 4 out of the last 5 years of the U.K. Zine Poll? I would echo Glover's last paragraph for North Americans and Denver Glont would be highly recommended.

Next is a look at the Canadian scene, from the viewpoint of Ron Brown, pubber of Snafu!. These comments come from both EE #21 and Snafu! #34-35.]

CANADA TAKES OFF, EH!

--by Ron Brown

"I think the problem in the States is that you're a huge country with a great number of active people all with their own ideas of how things should be run. And, because it's so large, splinter groups can find a considerable following. Contrast that with Canada where we have only four active zines at the moment. [Now there are six and possibly seven active Canadian zines] Because we're so few, we can influence each other, and do. The four pubbers realise they need each other and are willing to accommodate and help out the others. (The fact that we're all personal friends helps too.) In the States, four pubbers mean virtually nothing--and they can go on their own merry way, flagrantly violating, not only the rules and conventions of postal Dip, but the rules of common sense and courtesy as well.

...the Canadian publishers: Dave Carter [Sleepless Knights], Steve Hutton [No Fixed Address], Claude Gautron [Quinipique] and Randolph Smyth [Fol Si Fie]. What a motley crew they are! But all dedicated to making the game of postal Diplomacy enjoyable for all. You don't have feuds among us, or jealousy, or rivalry. Each has his own style and each complements the other. Dave can't publish pictures of his newborn son because he has a reputation to uphold, so I do it for him [Ron is known as the "Hobby Baby Custodian" because of the many baby pictures he prints in Snafu!]. Steve comes out with the puzzles I wish I had time to create. The rest of us can be "clean cut" because Dave takes care of the sleeze. Steve does a lot of hard work for us because he has game files going back before we even heard

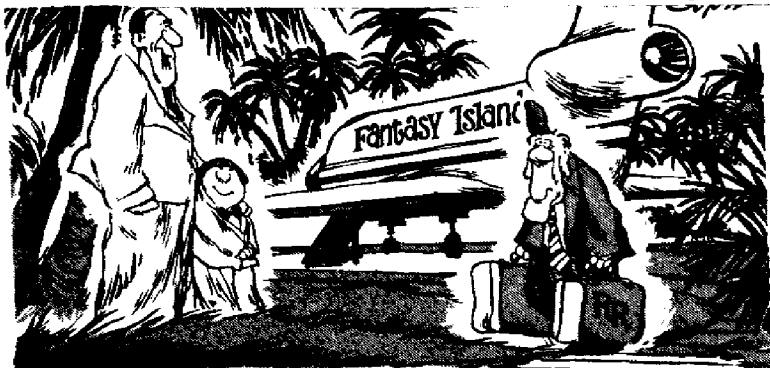

HIS FANTASY, TATTOO?... HE WANTS TO CUT TAXES, INCREASE DEFENSES AND BALANCE THE BUDGET ALL AT THE SAME TIME...

of this weird pastime. Randolph acts as "father confessor", filling us in on precedents and tales of days gone by. Claude is new to the club, but he guards the French presence. Recently he told me off for using Calhamer's spelling of Marseilles, rather than the correct Marseille.... We're a comfortable crew who enjoy what we're doing; and that's as it should be, n'est-c'est pas?"

((Yes, Canada seems to have ⑤ it all and I'll never forget that it was Randolph who sent me a novice packet, paying out of his own pocket, to someone he'd never heard of!))

((Now we turn to the mainland continent of Europe, to the hobbies in Holland and West Germany. First Holland. This next article was actually a letter written to me by Ivo Bouwman in January, 1983. In March of this year, a Dutch version of the Diplomacy game was released and the Dutch editors are in the process of creating a novice packet for their countrymen. There are four Dutch zines and all have multiple editors except possibly for Brutus which I've not seen. Ivo, along with Hauke Jansen and Roland Bakker are the editors of Je Maintiendrai. Jaap Jacobs and Frank Mulder are the editors of Oxymoron. And I think that is all the guys mentioned in Ivo's comments.....))

DUTCH DIPLOMACY

--by Ivo Bouwman

"Like you probably know, we only have some eight pages. You may, or may not, have ~~noticed~~ the small English version of Je Maintiendrai yet. Let me tell you, it seems a lot easier to me to fill up that "zine" than it is to fill a "normal" issue. Even though we don't have specific plans yet, Hauke and I are very excited about making an English version.

I think that needs some explanation. Like you probably already have heard from Jaap or Hauke, the Dutch Dip-Hobby is rather young. That is of course mainly because of the game not being sold until last summer. So whatever is going to happen now is unclear. Right now we have about sixty active postal players. And by "active", I mean they play the actual game with enthusiasm. But all the great "side-effects" that the Americans and British are dealing with, i.e. articles, letter columns, etc. are in fact unknown over here.

People just do not write us---not for an article, not for fun, not even with press releases. That is, to people like Jaap, Hauke and me, disappointing some days. But most of what we miss of that here, we catch up by reading a whole lot of English zines. And when we do get replies (like I know Hauke has got from, for instance, Woody [Steve Arnawoodian] and you), it all seems to be a lot easier. I mean, you can print them, but they also supply topics to write articles about; and questions to answer, etc.

So I think making an English version every now and then may be easier and can be a nice addition. For the time being, it seems unlikely that a wave of new writing freaks will appear in the Netherlands, so we stick to the foreign zines and slowly keep trying to reform the hobby here. Well this has become a different (and far more serious) letter than I had expected when I started. Well, what the heck?!"

((Since Ivo wrote this, the two Dutch zines mentioned above have developed strong letter columns, sometimes partly in English, and the press wars have really taken off, especially in Je Maintiendrai. Ivo has been to America two or three times and I believe he receives more North American zines than any other European.

Next up is Konrad Dolata to talk about the West German hobby. Konrad's article was originally sent to the British zine, The Church Mice, published by Dave Thomas and received such favorable comment from other British subbers that I wanted to print it in EE also. Konrad is a guest GM for a United variant called Psychosoccer in the British zine, Psychopath and will be publishing a zine of his own called Der Netzroller devoted to all kinds of variant games.

Within his article, Konrad describes how he came into contact with the British hobby via the Zine Bank run by Alan Parr, editor of Hopscotch. This is exactly the way I discovered the British hobby. North America could benefit by such a system and Steve Knight of Virginia has been thinking of making this a reality. Perhaps some day.....Konrad's article begins on page 7 .



A GERMAN VIEW OF THE BRITISH HOBBY
And THE GERMAN HOBBY

---by Konrad Dolata

My name is Konrad Dolata, I'm German, 27 years old and I have been enjoying PBM[Play By Mail] since the beginning of 1982. As I learned from Dave[Thomas, pubber of The Church Mouse], I'm the first German subber of TCM and he asked me to write something on the German hobby. So here you are!

Although I'm not one of the authoritative veterans, I'll do my best to give you some reliable facts. First of all, I would like to answer the question: "What does this bloke want? What is he talking about the German hobby?"

Well, it all started last year when I managed to get hold of 6 members of our Badminton Sports Club who were willing to play my first face-to-face Dippy-game. I had already got this jewel as a present two years before, but whenever I wanted to interest my friends they told me to bugger off: "Can't we play something that can be finished in less than 2 or 3 hours?" they kept asking me and so we always ended up with Cluedo and other family games.

But there it was. Dippy took me by surprise. I had never enjoyed a game like that before and although the game dragged on for a few months because we had to arrange several sittings(a very hard task that prepared me for the need of PBM), my interest was intensified.

As the German distributor didn't think of delivering extensive rules, we soon found ourselves in trouble. "Is this a stand-off? What about this complex situation?" We were completely lost with the small booklet. [When I was in West Germany, Konrad told me the German rulebook didn't explain terms used in Diplomacy very well]. But then I remembered an article in the professional zine Das Spiel and I wrote to Walter Luc Haas[the founder of the Diplomacy Hobby in the German speaking countries] in Switzerland. He runs several zines(more about him below) and his most famous one is Bumm, a Dippy result zine.

This has been my first contact with the hobby and together with the house rules--which helped us to get along--I ordered the zine and a few weeks later my first postal game was on its way. A second one followed and soon I found myself writing articles for his zines and buying games that I had hitherto never heard of(mostly from Avalon Hill). Shortly after this start, someone rang me up and told me that he had read one of my articles in Walter's zines and if I would visit them. It was a hobby meet in our town and from that time on I visit it regularly every fortnight.

There I met the editor of one of the largest zines in Germany and together with a few copies of hobby zines other than Bumm I left for home. I read about En Garde, Kingmaker and United, phoned the editor the following week and he gave me some more information about the games. As I wanted to join United, but all the leagues[part of the play in United] were in full swing at that time, I offered the game in our Badminton Sports Club and was astonished to get 13 teams within a week. The season was concluded within 5 months and there was a lot of fun despite the unlucky number of teams.

But work as a GM showed me that time is tight(there is a zine to type and this is sometimes a rather pressing activity as my final examinations were drawing near. But with a little luck I managed to pass them on June 3rd.). Our new season has just started with 30 teams in 3 divisions and a fortnightly turnaround.

When United became one of my favorites I learned that there was an International Tournament for any kind of United leagues, organized by the inventor of the game, Alan Parr. Writing to him, I got a copy of his zine Hopscotch and there I read about the Zine Bank. I sent some money and a request for some zines. I never expected what I got back: a full package with copies of the "cream" of the British zine scene. The first zine that fell into my hands was TCM--not because I want to flatter Dave but just because it lay on top of the package.

As I've got relatives in England--in Southampton to be precise--and I like the country, people and the language, it was quite natural that my interest grew. My idea was to expand my knowledge of gaming and to get international contacts. So I wrote to a number of editors(time and money allowing) and was astonished to get such a warm welcome to the British hobby.

As my finals drew nearer and nearer I had a closer look at my bank account and I found out that besides wanting to sub to even more zines, I actually could manage to write to the editors next in line. So eventually I got a sub to TCM,

((Continued on page 8)) (1)

which together with Perspiring Dreams and Greatest Hits (no answer yet), was my "second helping" (with such a wide variety of zines every choice is quite difficult to base on logical criteria. Therefore, the "second helping" does not mean that it is to be valued in terms of quality). Well, now I'm able to come to the point--take the above as a necessary preliminary account of my person which I believe serves as an explanation for this article.

If the German hobby had been compared to the British one on the basis of participants in Alan Parr's International United Tournament, a 1-1 relationship might have been established. But this is a false conclusion. There are no fixed figures but, in comparison with the large British hobby with its approximately 1,000 players/readers, there are only about 300 in Germany. This might be due to the fact that the hobby is still very young.

It all started back in 1975 when Walter Luc Haas, a Swiss teacher, edited the first issue of his Dippy-zine, Bumm. It took some time until the first German zines appeared in the late 70s but they all depended on the foundations of Walter's work. So let's have a closer look at his zines first.

Together with Dippy results, Walter issued translations and his own articles about Dippy and introduced British and American games that had hitherto been completely unknown in Germany. He created his service, Europa-Hobbies, which stores up to 2,000 different games that can't be obtained in German shops. (Except for some of the special shops which are scattered around here). He introduced war games, role-playing games, Fantasy and Science-Fiction games and made the appearance of fan-groups and zines possible.

Perhaps one reason for the fact that a Swiss introduced the games is that a lot of PBM PBM-games are considered as War-games (most of the board games are at least) and the Germans couldn't possibly promote such games after the two World Wars. But back to the hobby.

The backbone of the contemporary German hobby subbed to Walter's Bumm in the early days and they even learned to appreciate the accompanying chatezine Bumm-Spezial. The zine with the largest circulation was, and still is, his zine Joker which informs the readers about games that are rated as Family games and some of the subbers can't be counted as belonging to the PBM hobby. There's a subzine to Joker which is made up of articles on war games and Sci-Fi/Fantasy games.

The most famous German zines are: Der Grinsende Beobachter, Sauri Allstar Unlimited/Genesis, Die Pöppelrevue, Das Amtsblatt, Der Stabanzeiger and a few minor ones that are dedicated to, respectively started with United. All in all, there are only about 10+ zines compared to the 50+ of the British hobby.

But despite its comparatively small extension, the German hobby owes much to the British one (a circumstance that is very often neglected or even not noticed at all--except by the editors of course).

What is played in our zines? The largest amount is made up of Dippy--the game that started it all and the figures in the survey that Richard Walkerdine sketched out in Mad Policy #77 for the British hobby have many similarities to the German hobby. The second largest part of games consists of United, so that half of Alan's tournament was filled with German entrants.

Third in line comes En Garde which is expanding still as it has only been recently offered. Another branch is dedicated to 1829 and Railway Rivals, the former together with Civilization being the favourite of face-to-face games among the veterans of the hobby at the moment. There's hardly a con or hobby meet without them (some players even complain that they haven't gotten the chance to play other games!).

What else have we got? Another famous game in our zines is After the Holocaust (Ath)(SPI), which recreates the struggle for a technological, agricultural and



*military revival of 4 shattered areas. Well, not my cup of tea, but very popular with the hobby veterans. Apart from that game, all others are derived more or less from the English-speaking hobby.

If you compare British and German zines, one main difference is very striking: Due to our preference for perfect products, most of the editors tend to publish their zines in a very strict course of time and if there's a delay of a week or two this is looked upon as a minor catastrophe. They are sometimes missing the relaxed attitude of the British editors and subbers who don't mind some delays as long as the zine keeps running.

Furthermore the German zines extend their perfect production even to the outer appearance of the zine. Most are A-5 [refers to page length whether open-page or digest. Most North American zines are also A-5 whereas the British zines are A-4 which is larger than the 8½" by 11" typing paper we use] and there's a fixed number of pages in most cases to express this kind of regularity. As to the content of ~~the zines, the larger ones mentioned above are multi-games-reports without the light-hearted letter columns that make reading British zines so much fun. There are letters but only to such a small extent that a zine is generally dominated by reports/results.~~ the zines, the larger ones mentioned above are multi-games-reports without the light-hearted letter columns that make reading British zines so much fun. There are letters but only to such a small extent that a zine is generally dominated by reports/results.

One reason for missing contributions (articles/press) may be the fact that you have to type your items yourself so that the editors can put them in without losing too much time. This certainly cuts off a great deal of possible contributions as can be seen if I take former issues of Bumm-Spezial as an example, where Walter used to type all he got himself.

The only zine that comes quite near to the sort of British chat-zine is Sauri Allstar Unlimited/Genesis (see above) which is published by Christoph Schunck and Thomas Franke, two very proficient editors and gamers [True! See this season's Alsace-Lorraine on page 13!]. Thomas still tries to stay in contact with the international scene. He even types every bit you write to him and he takes the time to answer your letters eagerly. But as his finals approach this year, he might be forced to cut down his activities and this would mean a major cut-back on the entertaining chat. But I hope he will be able to cope with this pressure to preserve at least a small amount of his contribution to the hobby.

As to the German hobby may still be considered as one that still has to come of age (the veterans would lynch me if they read it--but compared to British standards, our hobby has got a lot to do yet). There's no such thing as your manifold organizations that might be valuable one day if the hobby keeps expanding. There's no need for a Zine Bank at the moment as you can still sub to all zines simultaneously but an institution like that would be a fine opportunity for those who are new to the hobby. A Variant Bank exists under the custody of Walter Luc Haas but, as he's not very communicative at the moment (getting tired of the hobby, I believe), it can by no means be compared to Andrew Poole's service [who runs the U.K. Variant Bank].

Games Start Service and Orphan Games Rehouser are [British] institutions that have never been thought of but in the last few months the discussion for establishing an organisation began with the idea that a Novice Pack should be worked out. With the famous German accuracy, this will have to wait for quite a while until all the pros and cons have been weighed up. After all, I think gamers are a bit like children everywhere. Whenever the word 'Organisation' is uttered, they raise hell and fear to be taken into a severe bondage. (Not only in Germany but also in Britain as John Dodd's article in Perspiring Dreams #33 showed by the reaction.)

To my mind, a growing hobby is in need of an organisation that keeps up the contacts. Otherwise there might be the danger that it is divided into several branches and that the hobby is no longer a united one. This is a question of values after all. Does the hobby have to be monolithic? I think, no, but in order to coordinate or rather keep an eye on what's going on, it is in need of a supervising organisation of one form or other.

A last criterion for a comparison of two hobbies are the hobby meets and cons. Compared to your regular ones, the German hobby still remains a field of single combatants who organise conventions at random, and there are only a few of both. Fortunately I've got two hobby meets in my neighbourhood but large areas of Germany are very bad because of the complete lack of such opportunities [Same in the South as I have to travel long distances to see other hobby members]

"INFORMATION ABOUT EUROPA EXPRESS"

--by Gary L. Coughlan

Whenever I get a sample request, I try to write each person and explain to them about EE (like the languages, what a MalMBERger is, etc.). Well, when I returned from Europe, I had 10 requests for samples so I think I will just put this page of explanation here in EE. It might also be good for the older subbers to have all this info concentrated in one place. I am sending a language chart to all the sample requestors so I won't go into that in detail here.

EE's sub rate is 10 issues for \$6.00. There are two game openings, when two current games end. However, to get in these two games, you must participate in the PDO auction (see page 30) where all money raised goes to our hobby services. Another way to get into games is by being a MalMBERger (for benefits see page 2). This name comes from a Swedish subber named Fredrik MalMBERg who wanted one of the EE games named after him and listed all his great qualities for this "honor". Instead I decided to call the EE standbys, MalMBERgers.

There are currently 5 EE games running: 3 are on 5-week schedules (Windsor, Rhino and Seawolf) and 2 are 10-week deadline games (Alsace-Lorraine and House of Bourbon). Each game has its own map each season and editorial cartoon (subbers are invited to send in cartoons for whichever game). The strongest country in terms of supply centers owned sees its language used for the names of the countries, the honorific title (like Herr, Monsieur, Mister etc.), the game color (each game has its own colored pages within EE) and even my name as GM. In case of ties, the Korean language is used. All games begin in Swedish.

On the game maps, a large capital letter denotes an army such as "A" means an Austrian army and "E" means an English army. Add a tiny "o" and the unit is a fleet so "Ao" is an Austrian fleet and "Io" is an Italian fleet. Units which are dislodged are not shown on the map but a circle is drawn around the unit which was victorious. Fleets on the south coast of a 2-coast province are shown in parentheses.

There is a picture contest of an EE subber in each issue. The current contest is on page 16, along with a further explanation.

Another point on the games: If the cartoon of a little man being flushed down a toilet appears in all the games in a single issue (this cartoon is used when a country is eliminated), then all the subbers get that issue for free.

Pat Hart of South Carolina does a DIPSCRIPTION of an EE subber in each issue. They always appear on page 2 and Pat bases them on what he has read about you in this and other zines.

EE has two subzines, one of which begins in this issue, and a third occasional subzine which also appears in many other zines about the hobby. MASS MURDERS, done by Bob Osuch, usually appears near the center of EE and is usually on white pages. It is a 2-week deadline game and I'm German and getting creamed. It features a great press war and I've always been a fan of lots of press. Bob is from Arizona.

The debuting(?) subzine is The Beholder by John Kelley and, in this issue, appears on page 42. The Beholder, for 15 issues, was a full-fledged zine until John folded it back in 1980. Now he has revived it as a subzine in EE and I know it will be a fine addition to EE. John is from Washington State.

The occasional subzine, also making appearances all over the hobby, is Mos Eisley Spaceport, published by John Michalski of Oklahoma. It appears on page 32 of this issue. You either love it or you hate it. I like the fact that he will print everything, even if he disagrees with it.

Another way to get free issues of EE is by catching me in GM mistakes. I don't like to make GM mistakes so I'm offering you free issues of this zine if you catch me in one.

For each game in EE, I set up the board based on the map in the previous EE. I write out the orders and double-check them and then move the units on the board. Then I copy this onto the new map, type up the game report and mail it out to the players. The zine follows within 2 weeks to all subbers.

Catching my GM errors thus gives the players a great advantage since they see their games first. But they don't always catch it. If a player catches it, he gets 2 free issues and the other players in the game get one free issue apiece. If a non-player subber catches it, he will get 3 issues of EE. I want my adjudications checked, double-checked and triple-checked. I have had games ruined for me by sloppy GMing, and I don't want that in EE. This should answer all questions, eh?

**EUROPEAN COALITION FORMS AGAINST AUSTRIAN AMBITIONS!!
 GERMANS AND FRENCH TO FOLLOW LONDON'S WISHES IN WAR!!!
 HAPSBURGS VOW TO BRING TROOPS HOME FOR CHRISTMAS!!**

Ω POSITIONS IN SPRING 1910 Ω

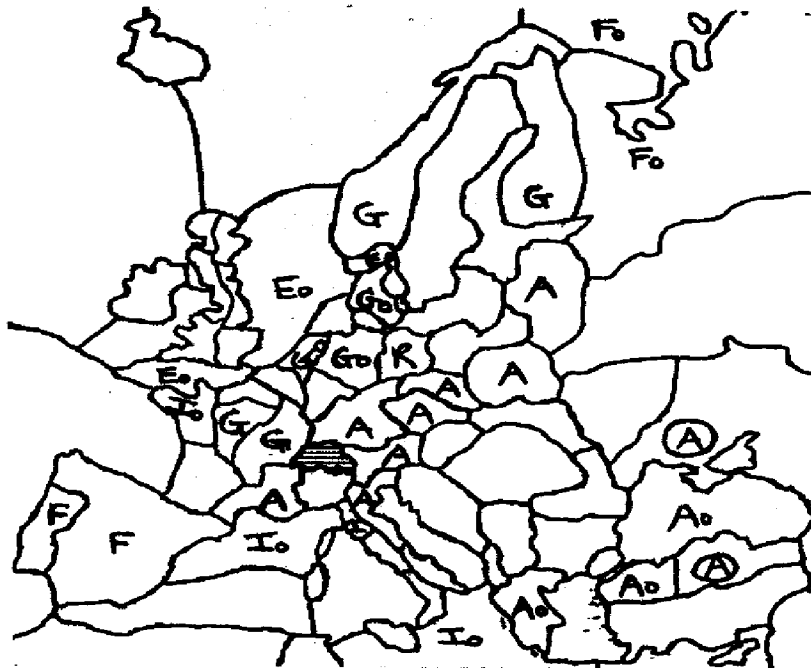

§ GAME: "Windsor" 1981 AN
 § GM: Carlás L. Kóullányi ur
 § NEXT SEASON IS: Fall 1910
 § ZAT: Friday, December 9, 1983
 § GAME COLOR: Z8ld

¶ GAME NOTES: Every 3 game years this game's name changes so it's Windsor again!

Thanks to Peter Ansoff for unused Malnberger orders. The concession to Austria failed and is repropozed.

Kerry Blant has a new address effective immediately: 8411 Forest Hills Drive, #106, Coral Springs, Florida 33065 USA.

§ Dialoggements This Time:
 Russia's Fleet Sevastopol and Fleet Ankara.

Your cartoon was drawn by EE subber Dan Wilson, quite some time ago but especially for this game.

Remember that dislodged units are not shown on the map!

§ ORDERS OF BATTLE FOR WINTER 1909 §

Ausztia-Magyarország: Build Army Trieste
 Franciaország: Remove Fleet Gulf of Lyon
 Olaszország: Build Army Rome

§ ORDERS OF BATTLE FOR SPRING 1910 §

ANGLIA: F (NTH) Holds, F (SKA) S F Nth
 (Mark Passio ur) F (ENG) S F Nth

AUSZTRIA-MAGYARORSZAG: A Tri-(VEN), A Pie-(MAR)
 (Kerry Blant ur) A (BOH)-Mun, A (SIL) S A Boh-Mun
 A (MUN)-Kie, A (TYO)-Mun, A Gal-(WAR)
 A Smy-(ANK), F (CON) S A Smy-Ank, A Mos-(LVN)
 A Rum-(SEV), F (BLA) S A Rum-Sev, F Aeg-(GRE)

FRANCIAORSZAG: A (POR) S A Spa, A (SPA) S A Por
 (John Marsden ur) F (BAR) S English F Ska-Nwy(NSO)
 F (STP-nc) S English F Ska-Nwy(NSO)

NEMETORSZAG: A Swe-(FIN), A (NWy) S A Swe-Fin
 (Jack Fleming ur) A Bel-(BUR), A (PAR) S A Bel-Bur
 F Hel-(KIE), F (HOL) S F Hel-Kie, F (DEN) S F Hel-Kie

OLASZORSZAG: A Rom-(TUS), F (BRE) Holds
 (Allen Pearson ur) F Wes-(LYO), F (ION) Holds

OROSZORSZAG: A (BER)-Kie, F (SEV) ~~XXX~~ Bla(x-Arm-OTB)
 (Patrick Conlon ur) F (ANK) ~~XXX~~ S F Sev-Bla(x-Arm-OTB)



((Might smear, but says VIKING))

Austria-Hungary to World: I paused from hostility to set an example to my fellow man. I cast my vote for peace---let's bring the troops home for Christmas.

Memphis to Austria-Hungary: Well, troops are on the move.....

England to Austria-Hungary: Maybe we'll make you earn this game, Kerry! All depends on what Jack does. If he doesn't side with us, you'll have this game

((Continued on page 12))

ENGLAND, DESPITE NORTHERN VICTORIES, IS THREATENED BY ARMADA!!
 GERMANS LAUNCH SURPRISE CONVOY INTO SWEDEN!!
 FRENCH ARMIES OVERRUN WESTERN EUROPE UP TO DENMARK!!!

OO POSITIONS IN FALL 1904 OO



§ GAME: "Alsace-Lorraine"
 1981 IC

§ GM: 71 | 01 | 21 | 41

§ NEXT SEASON IS: Spring 1905

§ ZAT: Friday, January 13, 1984

§ GAME COLOR: Gumbich'

¶ GAME NOTES: Your next set of orders are due, not only in 1984 when "Big Brother" (George Orwell) will be watching you, but also on Friday the 13th. Be careful!!

The 7½ week deadline game proposal was defeated. It is proposed again. Please vote with your next orders.

A 7-way draw has also been proposed. Remember a "No Vote Received" (NVR) counts as a "yes."

§ Annihilations This Time:
 Russia's Fleet St. Petersburg(nc).
 Your cartoon is from Garfield.

§ ORDERS OF BATTLE FOR FALL 1904 §

ET'ALLI: A Tri-(BUD), A (VIE) S A Tri-Bud, A Ukr-(GAL)
 (Kathy Byrne-yang) F (ION)-Aeg, F (SMY) S F Ion-Aeg
 A (SYR) S F Smy, A (TYO) S French A Bur-Mun

OSUT'RIA-HANGGARI: A Gal-(RUM), A Rum-(SER)
 (Bill Becker-ssi) A (GRE) Holds

P'RANGSU: A Bur-(MUN), A Kie-(DEN), A Ruh-(KIE)
 (Thomas Franke-ssi) F Eng-(IRI), F Pic-(BNG),
 A Bel-(RUH), F Iri-(NAO)

ROSIA: F (STP-nc) Holds, A (MOS) S A Sev
 (Helmut Schmidt-ssi) A (SEV) S Turkish A Bul-Rum(NSO)
 A (WAR) Holds

TOKIL: A Ber-(SWE), F (BAL) C A Ber-Swe
 (Kevin Stone-ssi) A (SIL)-Mun

T'OK'I: F (CON)-Smy, F (AEG) S F Con-Smy
 (Jaap Jacobs-ssi) F Arm-(BLA), A (EUL)-Gre

YONGGUK: F Bar-(STP-nc), A (FIN) S F Bar-Stp(nc), F (NWY) S F Bar-Stp(nc)
 (Mike Close-ssi) F (WAL) S F Lon, F (LON) S F Wal

Memphis to Alsace-Lorraine: Your 1904 Supply Center Chart is on page 14 .

Turkey to World: Let's put this game out of its misery. Vote yes to any draw proposal!

Italy to France: Do not speak a foreign language in the press! I don't know if you're attacking me or not. This game must be speeded up--or I'll die of old age--Becker already has arthritis and Stone is going senile. Please vote for shorter deadlines!

France to All: Sorry for voting against shortening the deadline, but I'm very much under pressure and like to negotiate properly. Perhaps in one or two game years....?

Memphis to Alsace-Lorraine: More press continues on page 14 .



Russians Try To Help The Sultan In His Struggle Against The Austro-Italian.

§ 1904 Supply Center Chart §

	<u>Gains</u>	<u>Losses</u>	<u>Retains</u>	<u>Has</u>	<u>Builds/Removes</u>
ET'ALLI:	BUD		Home, Tri, Tun Vie, Say	8	+1
OSUT'RIA-HANGGARI:	GRE	xxx	Ser, Rum	3	No Change
P'RANGSU:	DEN, KIE, MUN		Home, Bel, Por Spa, Hol	10	+3
ROSIA:		xxx	Mos, Sev, War	3	No Change
TOKIL:	SWE	xxx, xxx	Ber	2	-1
T'OK'I:		xxx	Ank, Con, Bul	3	-1
YONGGUK:	STP	xxx, xxx	Home, Nwy	5	No Change
				<u>34</u>	

Italy to GM: Do you want pasta for Thanksgiving? I don't--I want Turkey.

GM to Italy: Somehow I got that impression also.....

Italy to Turkey: Thank you for letting me share your country with you!

KGS to Memphis: If I get killed in a fire over Thanksgiving break (I've got three night shifts--42 hours), I will any excess sub issues to Mike Close. I feel bad after the letter he sent me. Of course I didn't feel bad enough not to attack him this turn....

Memphis to KGS: I suppose turn-about is also fair play.....

France to Germany: Sorry for my moves--can we negotiate again???

Germany to France: Well, is the end near? If you own Kiel, I can kiss this game goodbye. If I own Kiel, I can probably still kiss this game goodbye. Heck, that ain't so bad though; I'm only standing by for the free issues anyway.

KGS to Gary (with a wink): Tragic, isn't it, that I would stand by for purely selfish reasons. Tsk, tsk, tsk.....

Gary to KGS: You're just a sorry person!

KGS to Lamont: Sorry, Mike, but I heard you were a Dallas Cowboy's fan. Loving football is great, but the Cowpokes--yuk!!! Go Raiders!!

Memphis to KGS: That's pretty dangerous talk seeing as how you're living in Steeler country! My favorite team is the Raiders and the 2nd favorite is the Cowboys. I hate it when they play against each other--I never know who to root for. I guess everyone's like that when their favorites meet. Am I right or wrong?

France to Memphis: No, you are wrong! German horses follow the command "Hü" (or "Hue" if you like), not, "Hüt". Okay? Yes, of course, Rotkappchen was really "verschlungen" in the German version. No, I'm sorry, I think only the Grandmother was "verschlungen" by the wolf. I don't know exactly!

Memphis to France: Well, that's certainly different from our version. In the German one, Little Red Riding Hood is eaten by the wolf, then the Hunter cuts open his belly, and Little Red Riding Hood is saved.

Italy to Austria: I thought you might like to give me Bud for my birthday!

BB to KB: Kathy, you've convinced me. We didn't write. What's to become of us?²

Memphis to BB: You mean beyond dying of old age and arthritis?!

Italy to the Tsar: I also wonder what I am doing in the Ukraine! Can I help you in any way!

Germany to Italy: Do you want my help with Russia or not? If you don't need me, just let me know, so I won't feel bad when I squash you like a bug.

Memphis to Italy: And if you do want Germany's services, remember to say "Hü" and not "Hüt"! Now if I only knew what worked with Elsie!

Italy to Elsie: Why won't Gary let you come to New York? Is he always so mean?

Elsie to Italy: Moo.

France to Italy: Long live our alliance!

France to England: The Empire is declining, isn't it? But look at "La Grande Nation"!!!

Memphis to England: Down is not out, right?!! Now for some more Rhys!

Rhys of Cwmbau i'r Bolo (Part X)....A replacement appears--and another one is needed....

The International Game reconvened the next day, amid chaotic scenes as the audience discussed the previous evening's calamity. The crowd went quiet as the

((Continued on page 31))

(14)

POPE AND SULTAN CARVE AUSTRIA UP BUT CLASH OVER BUDAPEST, GREECE!!
 GERMANS VACATION IN RIVIERA AS ENGLISH FLEETS STREAM SOUTH!!

Ω POSITIONS IN WINTER 1905 Ω

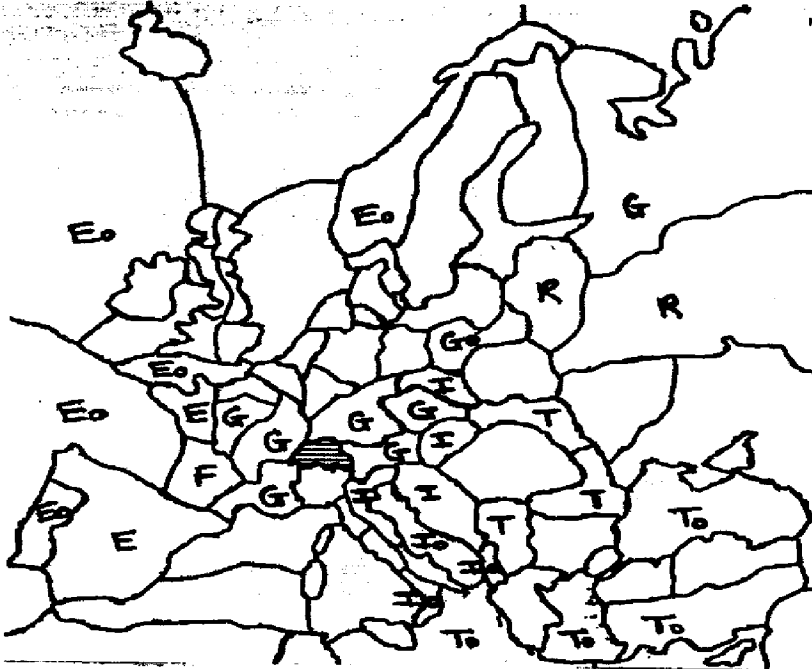

§ GAME: "House of Bourbon"
 1981 HK

§ GM: 710424

§ NEXT SEASON IS: Spring 1906

§ ZAT: Friday, January 13, 1984

§ GAME COLOR: P'urun

¶ GAME NOTES: Your next deadline is on Friday the 13th so beware. Three of you did not turn in any winter builds or removals so please be more careful with your orders. I, as the GM, can do nothing regarding your units unless you tell me, in writing, what is to happen. It is not my job to interpret what you want.

§ Annihilations This Time:
 Austria's Army Trieste and Army Serbia.

§ Dislodgements This Time:
 Italy's Army Bohemia and Russia's Army St. Petersburg.

Your cartoon is from Punch.

§ ORDERS OF BATTLE FOR FALL 1905 §

ET'ALLI: A Ven-(TRI), A (VIE)-Bud
 (Horst John-ssi) F (ADR) S A Ven-Tri
 F (ALB)-Gre, A (BOH) ~~NEW~~ Tyo (r-Sil-OTB)

OSUT'RIA-HANGGARI: A (TRI) ~~NEW~~ S A Ser
 (Brian Flower-ssi) A (SER) ~~NEW~~ S A Tri

P'RANGSU: F Iri-(LPL)
 (Eric Kane-ssi) A Mar-(GAS)

ROSIA: A (STP) ~~NEW~~ Holds (r-Mos-OTB)
 (Dave Carter-ssi) A (LVN)-Pru

TOKIL: A Fin-(STP), A Pic-(PAR)
 (Sellick Davies-ssi) A Par-(BUR), A Mun-(BOH)
 A (TYO) S A Mun-Boh, A Bur-(MAR), F (PRU)-Lvn

T'OK'I: F Eas-(ION), F (AEG)-Gre, A Bul-(SER), A (GAL)-Bud
 (Peter McDonald-ssi) A (RUM) S A Bul-Ser, F (BLA) Holds

YONGGUK: A (SPA) S German A Bur-Mar, F Mao-(POR), F Nth-(ENG), F Eng-(MAO)
 (Fred Winter-ssi) F Nwg-(MAO), F (NWY) S German A Fin-Stp, A (BRE) Unordered

§ ORDERS OF BATTLE FOR AUTUMN 1905 §

Et'alli: Army Bohemia retreats to Silesia
 Resia: Army St. Petersburg retreats to Moscow

Memphis to House of Bourbon: Winter 1905 orders are on page 16 .

The French In Liverpool: Yes, Paul, no-w repeat it again: Michelle, ma belle, son le mots gul((??)) vent tres bien ensemble.

Ankara to GM: Let me guess, the new French capital is Liverpool??

GM to Ankara: For one brief shining moment, yes!

GERMANY- The weather here is "falling" to the 90s now that winter approaches. Perhaps our illustrious GM and his countrymen would like some of our sunshine!

((Continues on page 16)) (15)



3 of Europe's Crowned Heads Are Stunned Over Bad Winter News!

TSAR AND GRAND VIZIER BOTH DISAPPEAR AS TURKS MAKE HUGE GAINS!!
 GERMANS TO OPPOSE GARLIC "WARFARE" WITH SAUERKRAUT!!
 MASSIVE FLEET BATTLE BETWEEN "LATIN SISTERS" APPEARS IMMINENT!!!

OO POSITIONS IN SPRING 1905 OO

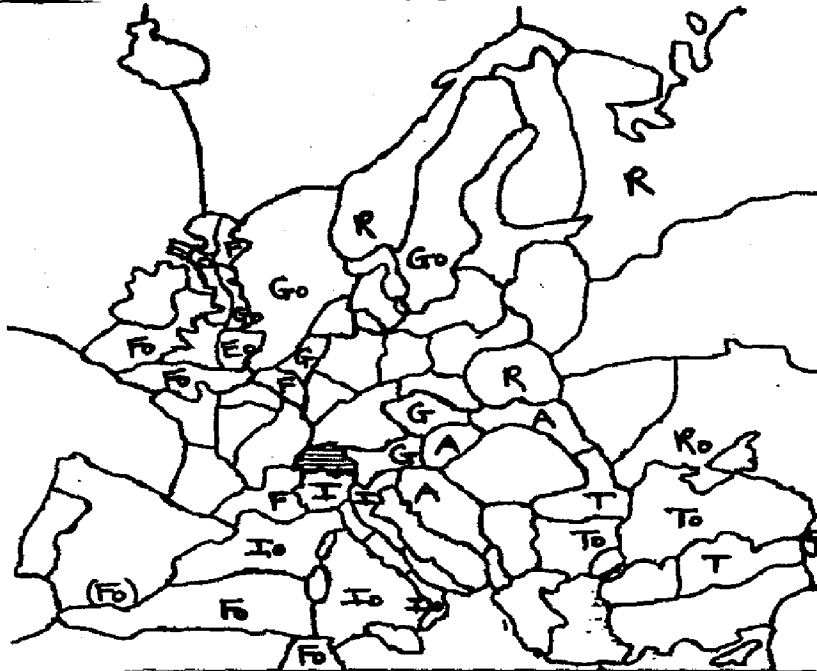

§ GAME: "Rhino" 1982 U

§ GM: Monsieur Garsaux L.
Çoughlanniqué

§ NEXT SEASON IS: Fall 1905

§ ZAT: Friday, December 2, 1983

§ Game Color: Jaune

¶ GAME NOTES: Be sure and notice that your next deadline is 4 weeks and not the usual 5!

Until November 25 you can reach James Briggs at: Box 1609, Junction City, Kansas 66441. After that, his address will be: PO Box 6243, El Paso, Texas 79906.

Again, let me know about Supernova. You get it or can have it sent to a friend.

§ Dislodgements This Time: Russia's Army Armenia.

Joke orders usually go in the press unless I have room with the regular orders. Your cartoon is from Punch magazine.

§ ORDERS OF BATTLE FOR AUTUMN 1904 §

Italie: Army Tyrolia retreats to Venice
 Turquie: Fleet Tyrrhenian Sea retreats OTB
 Army Armenia retreats to Smyrna

§ ORDERS OF BATTLE FOR WINTER 1904 §

France: Build Fleet Brest
 Italie: Remove Fleet Albania
 Russie: NRR! ☹ GM removes Fleet Black Sea
 Turquie: Build Army Ankara, Fleet Constantinople
 Build Fleet Constantinople

§ ORDERS OF BATTLE FOR SPRING 1905 §

ALLEMAGNE: A (BOH) S Russian A War-Gal(NSO)
 (Monsieur Walter Loy) A (TYO)-Vie
 F Nth-(YOR), F Den-(NTH), F (SWE) Holds
 F (HOL) Holds(NSU), A (HOL) unordered

ANGLETERRE: F (LON)-Wal, F (LPL)-Wal
 (Monsieur Jeff Sandelin)

AUTRICHE-HONGRIE: A Bud-(GAL), A (VIE) S A Bud-Gal
 (Monsieur Russ Rusnak) A Ser-(TRI)

FRANCE: A (EDI) S German F Nth-Yor, F Eng-(IRI), F Bre-(ENG), A (MAR) Holds
 (Monsieur Bert Schoose) F Mao-(SPA-sc), A (BEL) S German A Hol, F (TUN) Holds
 F (WES) S F Tun

ITALIE: A (PIE)-Mar, A (VEN) S Austrian A Ser-Tri, F Tys-(LYO)
 (Monsieur James Briggs) F Ion-(TYS), F (NAP) S F Ion-Tys

RUSSIE: NMR!! ☹☹ Has A (NWY) ☹☹☹ A (STP) ☹ A (WAR) ☹ F (SEV) ☹☹☹☹
 (Monsieur Ed Jacobs???) ☹☹☹ A (ARM)☹☹☹(r-Syr-OTB)

((Turkey's orders are on page 18 . I forgot to call a MalMBERGER for Ed, so see press on page 18 also.



The Fate of England Is In The Hands of Germany and France!

SULTAN AND HIS RUSSIAN ALLIES STALEMATE ITALY IN THE BALKANS!!

GERMANS MARCH EAST, SEIZING SWEDEN AND IMPERILING WARSAW!!!

Ω POSITIONS IN SPRING 1905 Ω

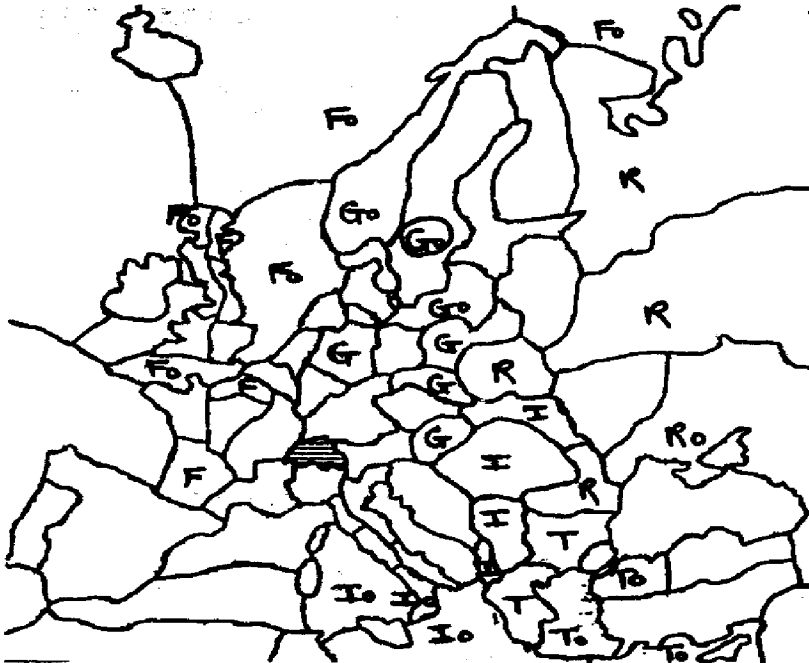

§ GAME: "Seawolf" 1982 CT
 § GM: 71012144
 § NEXT SEASON IS: Fall 1905
 § ZAT: Friday, December 2, 1983
 § GAME COLOR: Nok-saak

¶ GAME NOTES: Note that your deadline is in 4 weeks this time. The Sweden situation was an interesting one to GM this time. Earlier, in EE #23, I had the same type situation and consulted 4 other GMs before I adjudicated it. Thanks to Steve Arnawoodian for unused Malmberger orders. A F-G-I draw has been proposed. Please vote with your next orders. A "No Vote Received" (NVR) is counted as a "yes" vote for the draw.
 § Dislodgements This Time: Russia's Army Sweden.
 Your cartoon is from Mary Worth, and your game is now in Korean beginning in Spring 1905.

§ ORDERS OF BATTLE FOR AUTUMN 1904 §

Angliya: Fleet North Atlantic retreats to Clyde
 Rossiya: Fleet Berlin retreats Off-the-Board
 Army Norway retreats Off-the-Board

§ ORDERS OF BATTLE FOR WINTER 1904 §

Angliya: Remove Fleet Clyde.....O--U--T
 Frantsiya: Build Army Paris
 Germaniya: Build Fleet Kiel
 Italiya: Build Fleet Rome, Fleet Naples
 Rossiya: Build Army Moscow
 Turtsiya: Remove Army Syria

§ ORDERS OF BATTLE FOR SPRING 1905 §

ET'ALLI: F Rom-(TYS), F (NAP) S F Ion, F (ION) S A Alb-Gre, A (ALB)-Gre (Steve Knight-ssi) A (SER) S A Alb-Gre, A (BUD) S A Ser, A (GAL)-Ukr
 P'RANGSU: A Par-(GAS), A (EDI)-Nwy, F Nwg-(BAR), F Mac-(NWA), F Lpl-(CLY) (John Michalski-ssi) F Mac-(ENG), F (NTH) S German F Nwy, A Bur-(PIC)
 ROSIA; A (SWE)Nwy(r-Fin-OTB), A (STP) S A Swe-Nwy, A Sil-(WAR), A (MOS)-Ukr (Al Pearson-ssi) F (SEV) S A Rum, A (RUM) S Turkish A Bul-Ser
 TOKIL: F Den-(SWE), F (NWy) S F Den-Swe, F Kie-(BAL), A Hol-(KIE) (Rob Wittmond-ssi) A Ber-(PRU), A Mun-(SIL), A (VIE)-Gal
 T'OK'I: A (BUL)-Ser, A (GRE) S A Bul-Ser, F (AEG) S A Gre (Pat Hart-ssi) F (EAS)-Ion, F Smy-(CON)



Then What Is The French Fleet Doing In The Barents Sea??!

Memphis to Seawolf: Before I forget, let me know about your copy of Supernova. You get one free or, if you have it already, have it sent to a friend in your name.
Constantinople to Munich: So, who is France going to attack next?
Kaiser to the Sultan: Bzzzzzz.....

ONCE MORE OVER THE BREACH,
EH, GRISWALD?

Autumn 1904: Italy retreats A Tyrolia to Piedmont, A Trieste off the board

Winter 1904: Austria builds A Budapest; France builds F Brest; Germany removes A Vienna; Russia builds F St. Petersburg(nc)

Spring 1905:

AUSTRIA (Mazzer): A Tri-Ven/d/r to Vie, Alb, Otb; A Bul-SER; A BUD S A Bul-Ser; A SMY H; F GRE S RUSSIAN F Con-Aeg(NSO)
ENGLAND (Barno): F DEN-Nth; F SKA S F Den-Nth; F NTH-Yor
FRANCE (Cunning): A Bel-RUH; A BUR S A Bel-Ruh; F Eng-BEL; A PIC S F Eng-Bel; A LON-Yor; F Bre-ENG; F NWG-Nth; F Nat-CLY
GERMANY (Coughlan): F HOL-Bel; A Ber-MUN; A KIE S A Ber-Mun; A BOH S A Tyo; A TYO S AUSTRIAN A Tri-Ven; F BAL H
ITALY (Ozog): A Ser-TRI; A VEN S A Ser-Tri; A PIE S A Ven; F Ion-ADR; F Tun-ION
RUSSIA (Michalski): F NWY-Nwg; F StP(nc)-BAR; A FIN-Nwy; F CON-Smy; A Lvn-STP; A RUM S Austria vs. lovebirds (H)

What it is? Looks like the invasion has begun in earnest, only this time it's for real. Looking things over, I can't see much immediate damage being done on either front. Eric made a rather neat recovery to recapture Trieste, a move that certainly could have been avoided. Did A/G really think Italy wouldn't support Venice? Well, Trieste may yet fall, but it's Italian for the time being. Other moves of note were the French armies in Ruhr, and more notably Clyde. Surprise order for the season goes to John Michalski for his stirring rendition of "Fleet Constantinople to Smyrna". Congratulations, John.

On the home front, not much to report. We went fishing at Show Low last weekend. Caught 19 trout between the three of us. They were all over a pound, between 12-14 inches long. Yum, they were good. Just missed the flooding from what they tell me. The roads between here and Tucson were all closed for awhile (three or four days). Arizona's sewers are its rivers and washes. Once they overflow, it's "Katy, bar the door." Or is it "Goodbye, Charlie." I forget.

Summer and Fall 1905 will be due Friday, November 4, 1983.

PRESS

BUDAPEST-ROME: It's tough, cEric. As the song goes:

Each night I ask the stars up ab-uh-uv

Why must I be a teenager in luh-uv?

OZOG-MAZZER: Teenage Romance? Hah! We're in our tweens. Oh, glib glib glib.

ELF-MUNCHKIN: Yes, sign us up for the postal sex game, it's going to be a long, cold winter.

BLARFO-GMS: I don't "do" women--I do with women. (Or, occasionally, girls.)

LON-PAR: So you don't like black dots? I hope you aren't using a British board, because on US versions, all the dots are black.

MYKEY-CATHY: No, no, you're playing it all wrong. This is Glover's "Diplomacy Central". Get Eric to convoy you to Albania.

ERIC-DAF: Cathy told me of Gary's Grand Act of Deception at PudgeCon. I must admit, it was a good set-up, and it shows that Gary can lie, cheat and steal also. HOOOOORAY! Gary's one of us!!

MASS MURDERS

BLARFO-MICHALSKI: Well, Conlon's gone now, God rest his soul, and I hate to think of you having no one to shit around with so I went out and bought Jan Cremer's book too. How about this passage? "What a pleasure it is when your guts demand your whole attention: to sit and have a crap, quietly and voluptuously, reflecting or looking at a magazine or just staring at a mark on the wall that suddenly becomes a face or a monster or a cunt." Of course, it's been three years now since crapping really meant something to me. What about you?

ERIC-GARY: Cathy and I will "grin and bear it". Our love will keep us strong. Who will keep you strong? Michalski?

ENG-GM: I need a clue!

A MICHALSKI LOVE SECRET: Women also love humor. Say this line: "How'd you like to be attacked by a one-eyed trouser worm?" and you'll "touch bottom" every time.

FRANCE-ITALY: There's trouble in Paradise! And Germany's the serpent!

ELF-WITCH: I told you once, I'll tell you again: It's dangerous to walk around with exposed "mutant ears"! You know what I mean.

ERIC SWEET-CATHY SWEET: They will never defeat the "Love Alliance", no, not ever. Maybe they'll take us down a center or two, but our elfin spirit will live on. Besides, we want to stay lean and mean anyway, not getting stuffed on Gary Grouse and Mazzer Pie.

BERLIN-ROME: I agree with you. You are an ORC!!!!

BERLIN-PARIS: And I don't blame Eric Kane one bit for throwing darts at your picture!

BERLIN-ENGLAND: I've heard of The Attack of the 50 Foot Woman but I think The Attack of the 8-Center Female is much worse although their methods appear to be the same.

COMPUTER SCIENCE DEPT.: Since Daf was last in and first out and LIFO is the basic criteria for a stack, does that mean that Daf...uh, never mind.

GMS-BLARFO: Thanks Cutie. (That should be worth about 300 to your count.) Parquat? What's that? A kumquat with wings?

BARNO-DATE SERVICE: I'll give you four centers of your choice for Paula. We'll make the transaction at KazooCon.

MAZZER-"MAZZER": Who is Richard Gosh?

GMS-MAZZER: Scum-sucking hairball.

DAF-CATHY: "...then he was bouncing around the kitchen singing something about rolls and clover."

BERLIN-MARIE ANTOINETTE: In your next fairy tale ~~1/2~~ story, I've got a suggestion for you. You can either be "Little Red Robbing Hood" or perhaps more fitting, The Big Bad Wolf! If I'm in the story, I already know my lines: "My, my, what big teeth you have!"

BERLIN-ROME: And Marie Antoinette can do a story about you as Pinocchio whose nose grew every time he told a lie. You must be a real Jimmy Durante by now!

F-I-G TALES: Then Eric said to Cathy: "Me Tarzan, You Jane." Then Gary said: "Two's Company and Three's a Crowd and I've no burning desire to be Cheetah!"

SPECIAL OFFER TO EITHER G/E/R OR A: Special sale on the "Love Alliance": just join us for a guaranteed place in a three-way draw with Elf-Eric and Cathy-Sweet, your friendly hosts. Brought to you by Orczog. If you can't trust Orczog, who can you trust?

PUNK-POPS: Aw, you hurt my feelings. You wouldn't want me to "shitcan" an excellent typewriter which could someday be yours, really you wouldn't. And I'd rather stay home for a few extra years leading the sheltered good life; I can amass a small fortune for the purposes of Pudgecons, Cathy Sweets and getting a better financial start. Meanwhile Pops gets kicked out of the house at age 17 and winds up being trapped on the South Side living with a bread factory for a great many years, a fate almost as bad as Fluff throwing up in your underwear. Shall we continue lecturing one another on the virtues of life and how to live it or call it quits here? I know you have much more street-wise wisdom than this Punk, but please let me try it my way, THANK you.

MASS MURDERS

MESA-BOZOG: Yes, I guess I was a mite harsh with one as sensitive as yourself, so please allow me to rephrase my feelings on the matter: Eric, honey, I couldn't afford to go to Wichita, thus I couldn't pick up the typer. Now I really couldn't give two shits if you live at home until you're eighty, but please try to understand that we are all not in your lot, whether by choice or otherwise. Far be it from me to preach to you, after all, you seem to be able to fend for yourself just fine.

INTERNATIONAL NAME-A-GAME SERVICE:(James Wall, Prop.): You might call the next game MERE MAYHEM, if I know your games, Bob.

MESA: Uh, about that next game...

BERLIN-ROME: It is actions, not words or pistols to the head that impress me. And I'm very impressionable.

CHICAGO-MEMPHIS: I've nothing against you Gary, but it has been noted that your self-righteous style of play is very irritating to me. And as far as telling the truth goes, you wouldn't know truth if it fell and crushed your southern skull, damaging your southern mind and thus ruining your precious southern vocal chords. I've told the truth until I was blue in the face and you refused to believe it, choosing instead to ally with the greater of your two evils: Mazzerbrain. Our F/I/G triple could have chewed up the board with you getting a part of the three-way draw. As I told you truthfully, I would carry the three-way to the very end with no stabbing whatsoever. BUT NOOOOOOOOOOOO, the F/I/G triple is too easy for an ex-Mensan like you, you have to do it the hard way by bottling yourself up with the seedy eastern powers instead, dragging out the game for a few extra years. Tell me Gary where Germany will go now--where are the rest of your centers going to come from? Certainly not from Cathy, she has enough force to protect herself. They won't come from me, I can adequately plug up Venice until you begin to weary of your anti "Love Alliance" behavior. So y'all sit back and relax and stagnate the game until Pops gets too tired to care about abandoning us for a more exciting game (which is known to happen with the GREAT Chicago GMS, me notwithstanding). No problem, he'll just start another game with hopefully new and less hardheaded players. Amen.

BERLIN-ROME: How well the rest of the world remembers what happened the last time an Italian statesman dallied with a foreign queen. Do you? Another Actium is not out of the picture.

OZOG SPEAKS: Now I know Gary Coughlan CAN DO NO WRONG and is God's chosen diplomat sent to earth to instruct us lesser folk about his outhouse style truth and integrity. We will now sing the chorus, fall to our knees and worship him. Konrad may be right after all.

BERLIN-ROME: Behold now, Mazzermonster! Can you fill his skin with harpoons, or his head with fishing spears? Lay hands on him; think of the battle; you will not do it again! Behold, the hope of an orczog is disappointed; he is laid low even at the sight of Mazzermonster. No one is so fierce that he dares to stir him up! (Job:42 can go into further detail for you if you still need some convincing!)

ROME-BERLIN: As long as we're quoting each other's letters, how about this one you sent to Mazzer with a cc to me: "You (Mazzerslime) are the most ungrateful player I've run across in quite a while. With you, it's always 'What have you done for me lately?' Well I'm tired of giving you support and getting kicked in the teeth for it in your press and having you stir up my main ally (Cathy) against me for who knows what reasons." So Gary's solution is to ally with the scumbag.

BUDAPEST-BERLIN: You've clearly been to the wrong Mensa parties.

GMS-MAZZER: Flea bitten, slime snorting scuzz bucket.

GMS-RUSSIA: A lot of help you turned out to be. Now I'm glad I forgot to take the lens cap off the camera.

GMS-ITALY: With the way you got shafted last season, I'm amazed Cathy isn't jealous.

GMS-CONLON: That's the last time you'll leave me in a bad position! I remember the time before that--I couldn't straighten my legs out for days.

MASS MURDERS

BERLIN-"GARY GILMORE": Allow me to introduce you to France and Italy, the Bonnie and Clyde of this game! To quote from that movie: "They're young... they're in love... and they kill people."

GARY CAUGHT IN THE LIE: Here's another friendly Coughlan quote: "It is very apparent that you and Cathy can easily crush me without going through this song and dance routine, so for that reason I believe that you (Eric) are telling the truth, and there is no reason to go to such elaborate detail in trapping an already trapped prey. When I consider the alternative staring me in the face, I would be a fool not to say yes to the F-I-G draw. So I say yes.... So I will order Army Vienna to support your Army Trieste to Budapest I'll send a copy of this letter to Cathy so she will know that I have accepted the F-I-G alliance." Uh huh, right Gary. What has happened to you, has Mazzerworm possessed your soul?

BERLIN-ROME: Piedmont means Bye Bye and you consciously and deliberately made that decision. I think you will live to regret it unless you've just stopped caring about how this game goes.

BERLIN-PARIS: Another fleet for you, Marie Antoinette? My, what will the neighbors say to that? My only surprise is that it wasn't in Marseilles!

CATHY-BARNO: Ask me why I trust you? Maybe it's the info you have about me and my roommates. Blackmail does wonders, you know.

BLARFO-CUTE & CUNNING: Honestly, Cathy, every time you slide into another of my centers, it behooves me to spurt!

ERIC-GARY (AGAIN): You're wrong about comparing Cathy and I to Dave Barker and his roommate. Really, a truer comparison would be with Dick and Julie. Ah... love, love, love.

FROM CATHY'S RAMBLINGS #1: "Sleep was the next thing I remember until Eric couldn't stand staying in one place and had to go out to find the boys." Reminds me of Young Frankenstein where Madeline Kahn said: "You men are all alike, 5 or 6 quickies and it's off with the boys!"

MESA: Or in Blazing Saddles, where she sang: "...They just keep coming and going and going and coming... and always too soon."

GERMANY-FRANCE: I don't think Dolton's the "beast". I know you are.

CATHY-GARY: Don't forget to visit Glover and tell him what a vile creature I am. Allies? Who needs allies?

BERLIN-ENGLAND: Well, where did Cathy ramble to this time? Never have I seen so much greed and so little scruples.

BERLIN-PARIS: It seems that only the Catholics in France do everything the Pope says. Why not consider your own interests first?

NAPLES-KIEL: No, France and Italy are not being played as one country, we do have differing viewpoints on negotiations and tactics. We are one though in the fact that we don't attack each other, our love seems to get in the way and bond the alliance for the length of the game- something you'll just have to live with or die. Your loss you didn't believe in the three-way draw, there WAS something you could have done about it, you could have joined us. I told you before you had two choices: join the I/F or form the Grand Alliance against us. It seems you made your choice, we'll see if the Grand Alliance holds together.

BLARFO-BUDAPEST: I ought to send you a Jan Cremer Special one of these days.

BERLIN-AUSTRIA: I know that unless I removed my Army Vienna that I would have no chance of having you as an ally and I'm sure that this is easily understood everywhere.

BUDAPEST-BERLIN: The evacuation of Vienna is noted and appreciated. I'll send in my cleanup detail in due course.

BUDAPEST-PARIS: Now, ma cherie, are you ready to stop dallying with teenage elves and get together with a more mature type like me?

BERLIN-MESA: What's this? You go to Utah and then don't even tell us about going to see the spot where Gary Gilmore, our game's namesake, was executed? You're slipping.

BERLIN-RUSSIA: Have you met "Ericathy" of the Love Alliance yet? S/He plays Francetaly.

STAFFORD-COUGHLAN: Yes Gary, tell us all about how strong Mazzer's loins are!

HALF ELF-SLAVEMASTER: Aw, come on Gary, I thought you said to me a while ago all Mike had were "tender-loins".

MASS MURDERS

ITALY-ENGLAND: OK, here's my version of what really happened in this game:
AUSTRIA: "My last weak-spirited phone conversation with Ozog convinced me indirectly that we were going to stab one another. I then called my old cohort the Cough and ironed out the bad feelings."--Mazzer
ENGLAND: "Who wants a Cunning pulling your strings? Not I."--Barno
FRANCE: "I wanted to keep Barno alive to be used against Gary. I wanted to grab black dots but Eric said go for the F-I-G and finish off Barno, so I did. Eric, you sure screwed up, but I still love you, sweetie."--Cunning
GERMANY: "I couldn't trust the two lovers, that's all there was to it."--Coughlan
RUSSIA: "Love Alliance? Pass me the barf-bag."--Michalski
TURKEY: "Fluuuuuuuuuuuuuuuuush....."--Conlon
BUDAPEST-ROME: Thank God, now my MCI bill will be reasonable again.
BERLIN-PARIS: One thing we can agree on again is to cheer up Glover!!
BUDAPEST-BERLIN: Munich, Vienna and Moscow are right there for the taking yet they are still yours! Amazing. You're soooo glib!
BUDAPEST-BERLIN: Far be it from me to dispute the Book of Job, but I have no "muscles in my belly", only flab.
BERLIN-ROME: Judging from last fall, it looks like that Love Potion #9 back-fired on you!
MARIE ANTOINETTE TELLS THAT IT TAKES TWO HANDS TO HANDLE/A WHOPPER STORY: This time I play Sleeping Beauty and just guess who is my Prince Charming?! Anyway, when Eric kissed me, I woke up and was soooo hungry! I felt like I hadn't had anything for 100 years (actually I get a build or two every year so far and this is 1904!) so I just started grabbing anything I could. I like to think of myself as not bound by promises and that's the moral of this tale. Better visit me before I visit you!
THE BLACKHEART RETURNS: Once your land is overrun, Coughlan, I will personally take a sword to you and neatly sever your head from your shoulders, leaving the body to rot in the street. I visit the taxidermist to have the head mounted. It will make a good lamp base. "Sir?" says the taxidermist. What? "Shall I donate the brain to science or to Mensa?" No, don't bother. Just dump it in the trash, for it is too cluttered with the garbage of the south to be of any use.
BUDAPEST-ROME: I can sympathize. Gary's whining is hard to resist.
GERMANY-MESA: I'm glad the Romance Powers left me Munich during the Oktoberfest!
BERLIN-FRANCE & ITALY: THE WHOLE WORLD IS WATCHING! THE WHOLE WORLD IS WATCHING!!
MARIE ANTOINETTE: Why, didn't you know? Promises are made to be broken. Especially my promises!
MARIE ANTOINETTE-GERMANY: So you liked playing Civilization. huh? Maybe you'd like this then: salts, hides, ochre, gold, promises, cloth, bronze. Get them all cheap because they're really worthless!
MARIE ANTOINETTE-BERLIN: Gary, Gary, Gary! I never said that Ruhr and Burgundy were neutral zones for both of us! I only wanted them neutral zones for you. I never said that I wouldn't go into them. That's the way I work.
GERMANY-FRANCE: C.C. Liar! OH! See what you have done!!
MYKEY-MESA: If you care for another cohort for Stirring Dongs abuse, drop me a line.
ENGLAND-FRANCE: Mark my words that there will come a time when you will worship me as a god. You will be grateful to kneel down and lick the heels of my feet.
GERMANY-FRANCE & ITALY: I don't like having a gun stuck to my head and coercing me into an alliance. Ask nicely next time.
BERLIN-PARIS: You're despicable! I don't see how anyone can take someone else's home center and still be able to live with their conscience.
HEARD SOMEWHERE IN SANTA MONICA: "Good afternoon, sir. I'm Dr. Bob Bullsunn of ProctoKwik, Inc. To introduce the public to our work, we're offering free door-to-door estimates. So if you'll kindly bend over and spread 'em we can start you on the road to affordable proctology service." (25)

RUSSKIES STUN GRAND
ALLIANCE!

Autumn 1905: Austria retreats A Trieste to Vienna

Fall 1905:

AUSTRIA (Mazzer): A Vie-TRI; A SER & A BUD S A Vie-Tri; A SMY H;
F GRE S RUSSIAN F Con-Aeg
ENGLAND (Barno): F NTH S RUSSIAN F Nwy-Nwg(NSO); F DEN S F Nth; F SKA S
F Nth
FRANCE (Cunning): F BEL-Nth; F ENG S F Bel-Nth; A PIC-Bel; A RUH S A Pic-
Bel; A BUR-Mun; F Nwg-EDI; F CLY S F Nwg-Edi; A LON H
GERMANY (Coughlan): F HOL S ENGLISH F Nth; A KIE S F Hol; A BOH S A Mun;
A MUN S A Tyo(OTM); A Tyo-Ven/d/r to Vie, Otb; F BAL H
ITALY (Ozog): A Pie-TYO; A VEN S A Pie-Tyo; A Tri H/d/r to Alb, Otb;
F ION-Gre; F ADR S A Tri
RUSSIA (Michalski): A StP-MOS; A Fin-SWE; F Nwy S A Fin-Swe; F Bar-NWG;
F Con-AEG; A Rum-BUL

Very interesting season. The Russian movement affords John incredible diplomatic leverage, even if it was prearranged, which I doubt. At any rate, I don't think we'll see that boring stalemate that somebody mentioned last time, unless it pops up in endgame.

I got one set of orders after the deadline and accepted it only because the orders had the exact same effect as an NMR would have. In the future, if I'm not home when you call, give the orders to Dawn. She doesn't mind taking them.

Hey, did you get that 170-page VD? Impressive by bulk alone, a good letter column, poll results were well done and interesting, more than your money's worth for sure. I may get around to reading it all some day. Think I'll skip the house rules, but they were even shortened to 18 pages. Gary had a play in there too, and John an abbreviated Mos Eisley. What else? Maybe I'll comment again when I read the thing.

Thanks to all for the kind words about Woodpecker. I've received feedback from Peery, Michalski, Coughlan and Martin, who all said they enjoyed it and got a few laughs out of it. Even Ozog said he liked it. Linsey was the only one so far who expressed a negative reaction, but he obviously didn't understand the spirit in which it was done. It was more a parody on Woody than a fake. I guess I should have sent him a copy, as he took more than his share of abuse from "Woody", but wasn't that to be expected? I could have sworn I sent him one, in fact, I think I did. Oh well, tough shit and all that. Who loves ya, baby?

Autumn/Winter 1905 and Spring 1906 will be due Friday, no, make that Saturday, November 26, 1983.

1905	#	NET	COUNTRY	CENTERS
	6	1	Austria	Bud, Tri, Ank, Byl , Smy, Gre, SER (plays one short)
	1	-2	England	Edl , Syd , Den
	9	1	France	Home, Spa, Por, Bel, Lvp, Lon, EDI
	5	0 or -1	Germany	Home, Hol, Vie, Mps
	4	0 or -1	Italy	Home, Tun, Sst
	9	3	Russia	Sev, StP, Rum, Nwy, War, Con, MOS, SVE, BUL
	<u>34</u>			

MASS MURDERS

RUSSIA-FRANCE: Kisses are OK, but really, I need Barno's stamps more.

NICHALSKI-BLARFO: Good to know there will be real shit in this game since you're taking Conlon's commode comments. To welcome this, how about--- what else?!--some Jan Cremer: "Personally, I can't understand people who take a quick shit in a couple of minutes. They must have no spiritual life at all--they're the sort with nervous, unhealthy looks, who are always in a hurry. Crapping should be a completely selfish act, involving not another soul, just being wonderfully oneself, surrounded by one's own stench within four walls." I know I'm real selfish; what about you Blarfo?

A MICHALSKI LOVE SECRET: Old enough to bleed, old enough to butcher.

RUSSIA-GM: Oh well.

FRANCE-MALCOLM: Where's Malcolm? What have you English scum done with him? Must be hiding him in Yorkshire. I'll find him yet!

GARY-ERIC: How would Cathy know anything about my alleged "Grand Act of Deception at PudgeCon" since she wasn't there and I am quite sure I didn't tell her anything even remotely resembling that? However, I was surprised, unpleasantly so, to have your Italy tell my Germany that France had moved massively against me. Wish I could pull the wires so effectively in Paris as you do.

MICHALSKI-MESA: You said "two shits" when you answered Ozog. Does that mean you're into Cremer too?

MESA: I have a confession to make. I am Jan Cremer.

MEMPHIS-CHICAGO: What?! My "self-righteous style of play is very irritating" to you?! Well, EXCCUUUUUUSSSSSEEEEEEE MEEEEEEEEEEEEEEEEEE!! And you are right about the F-I-G alliance winning this game--only trouble is my Germany would have had to do 75% of the work for possibly 30% of the rewards with my back exposed to two, very close, lovers' knives for 100% of the time. You could possibly (possibly, mind you) view my situation objectively had not love, or something like it, got ahold of you.

MESA: Oh, oh, I don't want you, but I need you, don't wanna hold you, but I need to, Oh, oh, oh, you treat me badly, I love you madly, you really got a hold on me. Sing it, boys.

BERLIN-ROME: I am not an "ex-Mensan". I've never even been a Mensan. You must be confusing me with Bob Osuch.

BERLIN-"OZOG SPEAKS": Whaddays mean, "Gary Coughlan CAN DO NO WRONG"???? Have you looked at my position lately in this game? I am totally dependent on the goodwill of my former enemies. Don't worship me, just tell France to get her armies out of the Ruhr and Burgundy. You can do that, can't you? Sure you can.

BERLIN-ROME: Gosh Eric, don't you think you're taking my rejection of your alliance offer (Ally wid me and Cathy NOW or we's gonna snuff ya out RIGHT NOW) a little setiously? Like I said, I told you and Cathy what you so obviously wanted to hear. What was I to do, say "No, Eric and Cathy, I don't want to ally with you. Take Munich and crush me now." So I saved myself by my wits which was all the Love Alliance's lies had left me; I didn't have France's massive armaments nor Italy's total control over France's choice of friends and enemies.

MESA: C'mon Gary, Cathy's armaments didn't look that massive in the picture.

GARY-ERIC(AGAIN): No, the comparison to Barker and his roommate stands. Dick and Julie, as far as I know, haven't been in a regular Dip game (a postal one) together.

KIEL-NAPLES: So, you say France and Italy are not being played as one country? (Yawn). I might put some credence in that if you dig up one other person in this game who agrees with you. As I have seen it, Francetaly make war together and make peace together regardless of what we others do. Cathy had no better ally than me (Look at her position, gained mostly because I didn't oppose her but instead helped her several times) but, hey, when Italy said Austria is "our" friend and Germany is "our" enemy, French units, right on cue, went after the German ally. Next season, Italy says Germany is "our" friend and Austria is "our" enemy, French units evacuated, right on cue. I see they're back again. (Yawn).

CATHY-GARY: Let's see, how many German dots have I grabbed so far? Why there's ... no, I can't find one! Look, Gary, I told you I like England,

MASS MURDERS

CATHY-GARY(cont): not Germany!

FRANCE-ENGLAND: Want to try for another alliance? Huh? This time I'll offer you Skag and the Gulf of Bothnia. Is it a deal? Or better yet, I'll convoy you to Albania.

BUDAPEST-ROME: Oh I don't know, boring, stalemated games can be loads of fun. In SOHY Olsen, Brown, Langley and I played a hopelessly stalemated position for years and had a grand old time. The real boring situation is when one or two powers roll over Europe with no opposition. So relax and enjoy the "dynamic tension". If you really get bored, you can always stab France.

BUDAPEST-MOSCOW: F Con-Smy? Gag me with a spoon!

JOHN-ERIC: You're right, it was just a screw up.

PAR-BER: Well, did you meet Glover? Or did Woody scare him away? Did Gareth Cook give you your cute special Supernova? Does Bob wonder what the hell is this doing in the press and why don't I just write Gary? Well, I had to have some excuse to mention Glover Rogerson's name, didn't I?

BUDAPEST-EX-TURKISH STANDBY: That's the trouble with you uppity broads. You think the whole world owes you a living.

BUDAPEST-FRENCH UPPITY BROAD: Present company excepted, of course.

BUDAPEST-BERLIN: As you see, Gary, I'm perfectly reliable and trustworthy. All that stuff about Bismarck and his balloons, or whatever; that applies to Rrrrrrrrusnak, not me.

SLAVE MASTER-HALF-ELF: See, Massa Eric, Mistah Mike, he dun, Ah say, he dun gitted hisself some "Trieste Tenderloins"!

BERLIN-VIENNA: Someone's knockin' at the door, should I let them in? Lord, they're the devils, would you look at them! I'd heard about them, but I'd never thought I'd see....Ericathy!

ITALY-FRANCE: Without Love, I am nothing except a 2nd rate power.

FRANCE: "All you need is Dots, Dots, Dots. Dots are all you really need."

MESA: Dot's right.

MARIE ANTOINETTE-GARY: You can't hold out forever. I'll get Holland and Eric will get Munich and then we'll make this game a 2-way draw because no one can stop our Love Alliance. You got 2 years left at the max.

TODD RUNGREN: You can't stop... you can't stop...you can't stop... You can't stop love in action.

COUGHLAN-STAFFORD: No, Mazzer's loins are boring, let's talk about your cock instead. Why don't you cut it off and stuff it up your ass although it would probably feel more at home in your mouth.

BERLIN-PARIS: If my trailer fell on Eric, I wonder what water from a squirt gun fight might do to you!

HOLLAND: Let the dykes gush forth! The French invaders are arriving!

ERICATHY-GARY: Lucky for you I wasn't really mad last season--wait til I get pissed!

FRANCE-ITALY: Do you realize that I am only getting one build this year? I hate to lose my momentum like that. You know I'm used to two at one time.

BERLIN-ENGLAND: Let's tell "Joan of Arc"-- I mean "Cathy of Orc", to turn her little fanny around and go back to her own country.

AUSTRIA-ORCZOG: Getting a little nasty there with the press, eh Eric? Try to remember that it's only a game, just a silly game.

BOOPY DOOPY GOOPIE: This sentence is only here for Bob Olsen to read.

EUROPE 1905: The Love Alliance versus The Grand Alliance! Now that Germany has given thumbs down to the Love Alliance, will any other power side with them? Will England, whose three home centers are now totally French? Will Austria, who was slated to be snuffed out by Italian treachery despite his years of loyal friendship? Then what about Russia, who has carefully observed all of this? Could the Tsar feel secure as part of a 3-way with two such close allies as France and Italy? Is the Grand Alliance capable of holding a stalemate? Has the Love Alliance reached its high-water mark and now starting to recede? Tune in for the answers to these and other questions in the following seasons!

BERLIN-ENGLAND: Have you seen the devil with the ~~XXXX~~ blue dress on?

BERLIN-RUSSIA: I hope you appreciated your postcard from Europe! All Germany looks to your Russia as our Saviour from the Love Alliance!

organiser, Gary Coughlan, took the mike. "I'd just like to announce that, due to the indisposition of Marion, a standby has been found to take over the Russian position--Robert Jewett!"

A six-foot tall American GI broke through the gathering at the bar and smiled and waved at the audience. Kathy panted in delight, and Thomas looked rather displeased. Introductions at the Diplomacy board were soon made, and the game restarted with the Winter 1901 builds.

Not long afterwards, Rhys' discussion with Doctor van Lede was interrupted when an usher handed the Doctor a note. As he read it, his face became very pale, one hand covering his eyes in a gesture of remorse. Doctor O'Hare hurried over, and together they went out into the entrance hall of the hotel.

Gary called for the Spring 1902 orders. As the deadline approached, David O'Hare rushed back into the room and scribbled out his orders furiously. There was no sign of Michel van Lede.

"Where's Turkey," cried Gary. David looked up. "His wife's just been knocked down by a car outside the hotel! Michel's so upset he's locked himself in his room and won't come out. I think his wife must be dead!"

Memphis to Rhys: How educated we've all become as there was no need for any translator's notes this time, ha ha!!

France to Memphis: Did you enjoy your trip to Europe?

Memphis to France: Yes, very much! I particularly enjoyed staying up until 4 AM drinking DAB and schnapps with a certain Dinslaken citizen!

=====
KONRAD DOLATA ARTICLE.....Continued from page 9 .

"A fact that may serve for the stage of development that has been achieved is that in October the first Gamesday will take place and that everyone is looking forward to it. Although organized by the one and only professional zine, it will be the occasion on which large parts of the hobby will meet for the first time ever. Well, we'll wait and see. I can't think of more at the moment, but if you've got any questions I would be very pleased to answer them as accurately (this German syndrome again!) as I can.

I just got some more information about the genesis of the German zines from Thomas Franke. Well, here it is. As I mentioned above, it all started with Bumm. Before that time boardgames were only played by an in-group that got inspired by the conventions of British and American soldiers. Then Walter started games on a private basis by importing sets of Dippy from Great Britain and the USA (This developed into the Europa-Hobbies with its wide range of games today). Now more than 50 games have been finished and some 20 are still running although Walter has cut down the number because there seems to be a lack of motivation which may be partly due to the missing feedback Walter gets.

In 1977, Knut-Michael Wolf started Die Pöppelrevue. Being a player in Bumm himself, he began with economy games but developed it into a proper games-zine later on with articles, letter column and so on. In the beginning of 1983, he transferred his games to Stabanzelger (which came into existence in 1977 featuring Dippy/variants) and his intention is to publish a zine that only relies on articles and reviews. But there's the danger that his zine will soon become a professional one, thus losing the connections with the hobby.

It took some time and together with Der Grinsende Beobachter, it was not until 1979/1980 that more complex (board) games were played in the zines. Thomas Franke himself started as a GM in DGB and, as he wanted to introduce the British style (chat/press), his editor granted him the right to publish a subzine called Genesis. But, due to some very personal problems between Dietmar [pubber of Der Grinsende Beobachter] and Thomas, the latter had to look for a new "mother-zine". He found Christoph Schunck's Sauri Allstar Unlimited which developed into Germany's largest and most influential zine (Dietmar would certainly stone me for that, but although he's a friend of mine I can't deny that I like chatty zines more than result-zines.)

There are about 150 active Dippy-players in Germany (PBM, of course) with an additional 150 or so playing other games. There are also several fan-groups which center their activities on fantasy and/or miniatures but they are not at all involved in the hobby (Kind of a separate branch, so to speak).

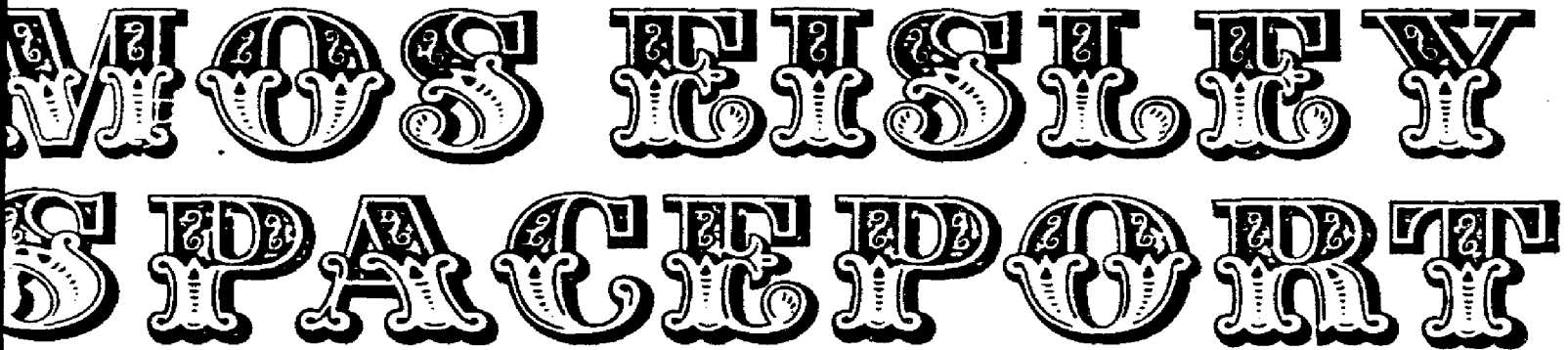

MOS EISLEY is a roving subzine of assorted bull from this year's Michalski Piss-Poor Award Winner, John Michalski, Rt 10 Box 526-Q, Moore, OK 73165. Your comments, and my silver chamber pot from Peery, will be welcomed. Probably.

HOBBY HUMOR DEPT.: This is really Hobby News, but it is so ridiculous, it's laughable. Naturally the source of this latest is the resident hobby laughingstock, Larry Peery (XENOGAGSME). As you may have heard, he ran a "Hobby Power Poll" to find out who bosses you around, or whatever he had in mind. Well, it seems four people, plus ~~Walker~~ Peery itself, actually wasted postage to vote. So, Peery being Peery, always on the alert to conjure up what DW's Walker lauds as Peery's "positive hobby contributions", has come out with a 56 page analysis of this 5-vote poll! Now, Linsey might put out 2 pages as a joke, or maybe Highfield or Barents run it as a feature item, but come on now, 56 pages? Better to have run 1 page and 55 blank situation maps. And Walker resented my quoting him saying that to sub to XENO, you need to enjoy "pages and pages of Peeriblah". Well, pages and pages indeed. One non-ECC publisher contacted me about this, and seemed upset by it. I find it hilarious myself, and good punishment for those who opt to pay Peery for anything of his. Oh, I understand Peery also proposes a Hobby Head Tax of \$1 on every new game player. Hey, more power to him! After all, I can label Peery as a west coast Robert Sacks or a useless dildo forever, and accomplish little except to alert people; this way, Peery is running himself out of the real hobby fast. So I say, Go Larry Go!

Other feuds in the news: Eric Kane of ANDUIN really had a funny line in a recent issue commentary piece. I really had a good laugh reading, at the end of a general I-want-to-avoid-all-controversy item, that is is sometimes hard to avoid with people like "that asshole Highfield". Wow. Folks, I'm not laughing at Eric now, nor even Highfield (at least for this), but rather, at the irony of the context. You see, that is exactly how every regular feud goes. Every hobby member except maybe John Boardman is in the hobby for fun. (Even Woody, whose idea of fun is to hold himself up for general abuse). But some people will really irritate you, and you, they, or both, will say so. You or they or others or all will print those comments. And there's a "feud". So hey, don't sweat it. Just join the fun. Listen in, throw in your 2¢, or 20¢, whatever. Why leave the BS letters to Berch-Walker-Linsey-Caruso-Martin-Coughlan-me, etc.? Throw in your views (attacks) also! Why should we be the only ones to spout off and have all the fun? Aren't your perverted, illogical, and disgusting views just as worthy of airing as ours are? And maybe we'll even luck out and see less of this silly anti-controversy stuff.

While we're on bad news, more or less, here's some more: a Canadian publisher has reported that Francois Cuerrier is returning. Peery, Cuerrier...when it rains, it pours.

Don Duck Williams had an interesting item in his latest adjudications of his Pariahs game. It seems my France (or whatever country I am, I'm not sure) lost its last unit in an annihilation in Portugal, but still hold Liverpool (not a home center) after fall. Don writes, "Is John out?" Gimme a break! C'mon, nobody ever heard of a country playing a unit short? I'm a one center power playing one unit short, that's all. I can submit press, no draw or concession can pass without me OKing it, I can share in a voted

draw, and in fact, can win by a voted concession! And this guy wants to know if I'm still in the game! Grrrrr.

In the good news area, Mark Larzelere (APALLING GREED) has come out with his 50th issue. AG always seemed to me to be the typical dipzine: letters a bit, some comments or news, mostly games and press and humorous filler. Kind of like Heinowski's TER-RAN. (Both ditto, harking back to early hobby traditions). I was surprised to notice that I am one of the original subbers (I'd forgotten). Congratulations. In one piece of personal commentary/background (news to me, and I like such stuff), Mark mentions how the press will ignore people and facts to write a story, any story, and will invent things if they don't have anything real that's juicy enough. Miss America commented on the same thing herself in another forum recently, and local contacts who had been robbed or something found too that the press will add description they never gave, recounts they never mentioned, etc., just to make the reporter/paper look better, irregardless of fact. How many people actually think there is much more to the fairy tale image of the heroic investigative reporter than just fairy tale? I guess once in a while we need to be reminded that reporting is a racket like any other, and they'll do whatever it takes to make a buck. There are fewer ethics in the media than in a dipgame, if that's news to you.

The recent heavy rain here is a good example of the sensationalism that wracks even the mainstream press. Relatives wrote from the north that they'd seen all these horrors, and how were we doing? Well, we did get a lot of rain last week, but the story the TV and papers went after was, search the city and state for the worst possible situations, and then report it as typical. I got off early, and had to detour, that's all. We got a year's rainfall in two days, some cowboys drove thier pickups into flooded underpasses at 60 and for some reason couldn't make it out the other side, and you'd think from the media that the world had ended here. Shit. It cleaned my car, gave us a break from the heat, and filled the city water supply lakes, that's the real story. Next morning--hell, that evening--the big rain had subsided. Kids got home from school early, that's about it. Big news, right? It was by the time you saw it!

In the course of doing the preliminary draft for this, a bomb went off in Beirut. I was a t drill that day, and all the teenagers and jerks were kidding about war. One quick way to shut them up is to ask, war-on-who. They hadn't thought of that of course. Reagan later said we won't add or withdraw troops: if we add to them, it would only increase targets. So why not reduce the targets to 0? What are we doing, aside from keeping the airport open? (Open to supply ourselves). Does anyone think that the occupation of a strip of land in west Beirut accomplishes anything? Why not just arm our friends and pull out? If the Lebanese all kill each other off, who really cares? It doesn't mean one fart in the wind to me. Maybe we should stand back, let them reduce their own numbers, and then let Israel go burn Damascus to the ground next time.

Just in: Marines invade Granada. Now THAT's what Marines are for: overthrowing Communist regimes!

Well, Halloween is almost upon us. Ol' Fluff Shaffer here, who doesn't like his neighbors in his new neighborhood, has thought of a good idea for Halloween. He proposes to buy a case of prophylactics and give them out to the trick-or-treaters. Figures it will really impress the parents that he cares. . . Oh, speaking of Fluff, Claudine got a little upset with him here the other day. It seems that he called, and I laid down one phone to go to another. Our little guy, 7, went to hang the first one up for me, but listened in for a moment first. Fluff had just been told I'd be working the Tax Commission booth at the state fair that weekend, so being the Fluff, he offered to come by if he got the chance "and I'll wave my dick at ya!". Well, that's the part little guy picked up, and he thought it was hilarious. When Claudine asked what he was laughing about, he told her. She didn't think it was very funny. What do you think?

((Continued on page 34))

33

LETTERS

KATHY BYRNE, BNC

About time you wrote me, I was beginning to think that you had replaced me with a woman (younger and smarter) ((oh, if only I could...)), or worse yet a robot or worse yet a Woody. Speaking of which, we are almost free--next Saturday John and I are taking Woody and Gary to the airport. I've already written to Mayor Koch and Governor ~~XXXXXXXX~~ Cuomo and requested that they not be allowed to return to NY. I am trying to have them listed as undesirables: a gay and a southerner!
~~XXXX~~ This is our chance to get rid of both of them! I told them we can keep the hamster population to a minimum if Woody stays in Europe!

So ByrneCon 47 is New Years--well, forget that--Thanksgiving Con is 69! My honey is leaving his shrine and spending Thanksgiving with me, Gary is leaving Elsie for me and Mazzer is leaving the negotiating table (to sell Amanda to the Arabs) to be in NY. Now this should be interesting--3 foreigners and the East Coast Clique! Mike ((Mazzer)) already wrote requesting membership--he's in! No one will ever call him dumb.

You are right about one thing--Balt-NY-Chic crowd are the hobby! Peery and his Blue Book has a lot of potential for Fantasy Island. When will that man ever learn--it's bodies that count! And not only do we have bodies--we have sexy ones--and that is not even counting Woody!

((Whatever you say...)) ((And keep in mind, Larry would prefer Woody)). J.M.

ROBERT OLSEN (excerpt)

Maybe next year I'll declare the house a nuclear-free zone...or a water free zone.. definitely a soap bubble free zone. I'm going east to ByrneCon at Thanksgiving so I'll see what KB puts up with..my big chance to meet the ECC. If Crud is not wearing at least a pointed black hat or better yet horns and a tail, Ill be totally disillusioned.

In answer to something in a recent MES--Woodlawn is STILL not finished, and I can't see how it could be before the snow flies. Too bad you didn't get to see it in its full glory: it was like driving through the Grand Canyon--majestic vistas, rugged impassable canyons inhabited by lost tribes of stranded motorists, sights no man has seen or wanted to. All scraped away now, and by 1990 it'll all be covered with blacktop. Oh well.

((Gee, and I thought 149th Street here was bad, when they scraped off the pavement and left it for 5 months. Of course here, with only climate instead of weather, the baked clay soon became harder and smoother than the original was by a long shot.

So you're off to Flushing, hey? Well, keep in mind how they insulted your PCon II when you're there. Try a Fluff Shaffer imitation with Julie or something: really wow 'em with Midwestern culture.)) J.M.

Here's a little piece of filler news-item that someone sent me. I retype it here verbatim:

EUROPEAN BISHOPS JOIN NUKE DEBATE

"Plagues and famines and earthquakes and sticks that poke out your eyes and kill you on jungle trails are okay", European bishops have decided. The bishops stated that such things "came from God." "Nuclear bombs would be okay too," the bishops stated, "but only if God dropped them".

 Ain't it the truth? Remember, you saw it here first, not in MANEATER.



No promises on the letter column this time either. It's either going to be small or about average but not gigantic, how's that. First up we have the people from the pictures who are now going to respond to your comments about their pictures. The new picture contest is on page 16, with details, and has a deadline of December 2nd. First up, is Simon Billenness, pictured at the top left. Simon was ~~mentioned~~ commented upon in EE #26 and Simon says.....

Simon Billenness(United Kingdom): "So you want a rebuttal, well here 'tis.....Steve Knight is just plain wrong. I have left newly-bought records on the train, I have spent two hours chatting to somebody who I thought was somebody else, I play fantasy role-playing games by post, but I have never worn mismatched socks. Me, touch drugs? Balls. Everyone I meet is amazed that I've never smoked pot.

Robyn Finley: "Up and coming Pizza Hut assistant manager"--yecch! Actually I'm a student who wants to be a social worker. Private business stinks.

Pete Tamly has met me many times and is just trying to annoy me, so I'll ignore him.

Steve Arnawoodian is cute. I shall tell my mummy that he likes the way I do up my tie. She taught me and she'll be terribly impressed.

Michel Liesnard: "Heavens, that bloke must be European." Well, your first sentence was all right, Michel.

Bill Highfield: Me support Mondale! Rubbish, he's far too right-wing. I find few American politicians worthy of support though Anderson was an honourable exception.

Mark Luedi, I can't understand. He shouldn't write when stoned.

Jim Williams is no poet.

John Wilman: I am not an "angry young man" and if you make that accusation again I shall punch you on the nose!

Cathy Cunnig is cute, so I'll forgive her for mistaking me for that 5'8" weedy wimp, Peter Northcott."

☐ Thanks Simon. He signed off his letter with "Peace, Freedom and Truth. Michalski up against the wall." Now for the man who was so heavily complimented in EE #28, Mike Mills whose picture is below....



Mike Mills(New York, USA): "Let's look at the facts. You run my pix, print the replies and then skip the country! What were you afraid about? Was it that I might seek revenge for the lies and evil, vicious taunts you created in EE about me? Have no fear, you'll not remember what you did when I get my revenge!

As for the pix, it was taken in Fall 1978 and I was 23. It was for a school graduate program of some sort. I don't know why all those people thought I was a European. Then I read all those guesses: Neubauer, Thomas, Murray! Liesnard! Perlmutter(MAKE ME SICK!), Woody?! I damn near fell on the floor laughing. I bear no resemblance to the Armenian Hamster!

I can forgive the blind for being led around by you, GC, but in the future they will have to bow low...lower still...if they wish to remain in the good graces of PDO (Peoples' Diplomacy Organization, one of whose projects is the hobby auction (see page 30)).

It figures that Woody would guess right. He met me in 1980 at some Con. He has a long memory. That simp stuff comes from the mouth of Dick Martin, that great sage of Maryland. Only Woody would be so silly as to keep repeating the words of that man, but he does. I guess Woody is getting old.

Let's overlook the comments and I'll say something about myself. I'd rather play Austria than anything. I can't be trusted and am not an ally player. I'll slit your throat and tear out your spleen for your last center; forget about the charm! I'm the antithesis of Duke Michalski on politics. We like the same things, but I can't see how he figures to get what he wants, doing things the way he wants.

((Continued on page 36))

35

MIKE MILLS PICTURE RESPONSE.....Continued from page 35.

"Ah yes, the earlobes are erotic. Oh yes, and I have a sensitive mouth, but I've never been to any wimpy art school! I was a mass communications major and doubled it with sensory psychology and then added a Masters in mass communications. So, now it's publishing and editing stuff for me.

I hate ties and won't take a job that needs one. Thoreau said, "Beware endeavors that require new clothes." I wear jeans, flannel shirts in the winter with boots and sneakers and T-shirts in the summer.

I believe that I led a previous life as a sergeant in the GrossDeutschland Division in the light infantry, but got snuffed at Kursk. Before that I was a pilot in the Lafayette Escadrille and a cuissaire in Nappy's army who got snuffed at Waterloo before the squares.

I'd like to thank all those people who guessed wrong and I'd like to stab Woody real soon for his guess and Martinesque remark. (Oh, I'll see you in November, eh?) Will the Armenian Hamster be there?"

Yes, Woody will be at the ByrneCon November 25-27 (Write Kathy Byrne, 160-02 43 Ave, 2nd Floor, Flushing, New York 11358 USA or call (212)-353-9695) and both Kathy and I have bet him money that you will show up so you can help stick it to him just by showing up and then you can stab him in a game. Latest details say that those coming are: Mike Mazzer, Bob Olsen, Mark Luedi, John Boardman, Bruce Linsey and possibly a group from Chicago plus the regulars so there might be as many as 30 people showing up. Eric Kane, pubber of Anduin, has offered to put people up at his home also, so Y'ALL COME!!

□□□

Lee Kendter, Sr. (Pennsylvania, USA): "Hope you had a good trip! I was wondering if you would do me a favor? Since you have a reasonable amount of European subbers, would you mention the following items for me in EE?"

(1) I am issuing Miller Numbers for Europe. So any publisher over there who wishes one only has to ask.

(2) I would like to purchase the British Diplomacy set. If any of your English readers would be willing, I'll send them money to purchase me one and ship it to me."

Lee's address is: 4347 Benner St., Philadelphia, Pennsylvania 19135 USA and he publishes Alpha and Omega, the Miller Number equivalent of Everything. AO is available for 3¢ a page plus postage but you can send one dollar or so and Lee will keep you up to date on your account.

□□□

Joan Extrom (Oregon, USA): "First of all, welcome back to civilization! Secondly, why in the world did you voluntarily spend almost a month with Woody?? And third, you went to London to see The Lamb--I plead ignorance. What's The Lamb?"

Started a tape to you last week, but the recording quality was poor, Samantha's [Joan's daughter] fussing came thru more clearly than anything, and I realized it was a 60 minute tape and decided it would be unfair to inflict you with 60 minutes of all that. How long are the tapes you exchange? We may give it another try when Samantha's in a better mood.

We're enjoying Europa Express. I don't play Dip, but still enjoy reading about the games, with the different languages you use. Don't know if we'll venture any guesses in the picture contest. Don't feel like we know many hobby personalities. Must say that Mass Murders press is quite entertaining.

I'm anxious to hear the report of your trip. Was this your first time in Europe? I spent the summer of 1971 in Europe with my high school French teacher, two other chaperons and 25 other student. We rented Volkswagen buses and drove and camped all over."

Well, it was my first time to Europe and I'll tell all about it in the December EE or in a special edition. Woody is a very good traveling companion except when taking so long to order in a restaurant when the rest of us were starving and had already made our choices. But I'm no saint either. The Lamb is a London pub where the British hobby meets to socialize the 1st and 3rd Wednesdays of each month. They were nice enough to hold a special one on the 4th Wednesday for us. Most tapes I get are 60 minutes, except from Jim Meinel and Mike Mills who prefer 90 minutes. Glad you like the MM press and I enjoyed hearing from you.

□□□

(35)

Mark Keller(California, USA): "I've also enclosed the photocopy of the cover of an issue of Hai Jikai[Mark's zine] I had returned. Is there such a regulation? Does it apply to mail to Canada? Have you had this problem with EE? This is the first and only issue I've had rejected to date."

□ Well, the Post Office clerks told me, when I took EE to them that all papers going outside the United States had to be in envelopes but it's really whether some zealous clerk(read prick) wants to get picky. I still send EE in envelopes outside of North America but I just send the zine itself to Canada and have not had any trouble. In a related development, I used to tape the stamps when I mailed EE. I got one back(Bob Olsen's) and was terrified that all would be returned due to the "defacement". No others were but I switched to mucilage. I work with 2nd and 3rd class mail. First class mail clerks(the ones you see in the branch stations) are snotty creeps and tend to give the Post Office a bad reputation.

□□

Mike Close(United Kingdom): "I'm heavily into American Football lately. One thing puzzles me. I know that they play each of the other teams in their division twice, home and away, but how do they decide who to play from the other divisions(and league)?"

□ I talked to Mike "Football is my life" Mills about this and he says: Who you play ~~depends~~ this year depends on your record from last year. For instance if your team was 2nd in your division, you will more than likely play most of the other teams in the League who were 2nd in their division. In other words if you are a lousy team, chances are you will not be paired with the top team in another division. Do y'all like the cheerleaders?

□□□

Rich Delzer(Wisconsin, USA): "In your editorial[in EE #26] you stated that a few petty things were said about you. That is just human nature. Some people can't resist an easy target and when you publish a 'zine you assume a very high visibility. The better the 'zine the greater the visibility. Use your confidence in the quality of your efforts as your defense. They will only embarrass themselves when what they say proves out not to be true. In this instance, I can say I don't know what was said or by whom. ~~Only~~ Only know you from your magazine and your very helpful letters I've received in the past. You will come out of this A-OK."

□ What happened to me last winter at the hands of 6 zines and 3 subzines was not "just human nature." I had just gone through a very bad time with Dick Martin and Dan Stafford making comments about me. Then Konrad Baumeister jumped on my back and I answered these 3 in EE. These 6 zines and 3 subzines said nothing about what these guys did to me but, hey, just as soon as Gary responded, it was open season on me and me alone. I will admit that I overreacted and should have been much briefer in my response but, when I involve my zine in controversial matters, I make sure the readers know exactly what is going on and that takes a lot of space. ~~Red Walker said of this period in Anduin #19/20: "...the Coughlan/Stafford~~

matter, let me add a couple of thoughts. Yes, Stafford's comment was (marginally) libelous. Yes, Ozog showed poor judgement in printing it. Yes, Coughlan overreacted. Yes, the matter has been blown all out of proportion. However, on balance, it seems to me that some people appear to be trying to push Gary into a corner, to goad him into further overreaction. I am no stranger to this technique: I've used it myself against certain people who had a tendency to overreact. My hope is that this whole thing can be allowed to blow over, without so many people trying to play dog-worry-bone with Coughlan. Unfortunately, there seem to be some people who will not let go. Gary is not completely innocent in all these various feuds connected with him at the moment, but he is also certainly not completely guilty either. There seems no reason for him to be bullied as savagely as he has been in some quarters."

I have also heard this comment about being a pubber, that somehow you must expect to take shit off any Tom, Dick and Harry that wants to dish it out. My fundamental differences in this past situation were with Martin, Stafford and Baumeister, whom I answered. When the 6 zines and 3 subzines started their smear campaign against me, I ignored them and anyone will look high and low in EE to find

Some Are More Equal Than Others

any response because there wasn't any. It took the bulk of these zines two months to maul me and then they ran out of lies and distortions, though some went on after that. Four of these people have printed a few paragraphs of regret, without mentioning the persons by name who so savagely and cruelly tried to wreck my reputation. Contrast that with the pages and pages of attacks on me, going into my sexual life, my mental state, even cracks about EE and I was fully identified and mentioned by name. Yes, life isn't fair at times, is it?

At any rate, Rich, I overlooked all of that except for the one editorial I mentioned in EE #26. That was so bad and so low that it still gnawed at me. (These other attacks do too, but not like this one did). I am glad that it got worked out so I didn't have to bring it into EE. I didn't want to have to type that shit.

What was funny, and illustrates the mentality of these 6 zines and 3 subzines was that when Martin and Stafford and Baumeister printed those things about me, ~~was~~ one guy said nothing. Then I reacted and he commented on it in his publication, inviting my response and my explanation. I sent a letter and he ripped it apart in front of all his readers and got a lot of cheap shots in as well. He then wrote to the letter columns of 2 well-known zines further running me down in front of yet more people. He also made derogatory comments about me in some of his games' press.

When this vicious Brawler editorial came out, I looked in vain for some reaction from this guy, anything at all. Zilch. He was like these others and possesses a double standard. In this case, it was okay to rip Gary apart and at length and in many zines and subzines and no one said anything (until this Brawler editorial). But these people, even when haltingly apologizing to me in their zines (if they apologized at all publicly), can't bring themselves to criticize Martin, Stafford and/or Baumeister much less even mention their names.

Like George Orwell said, "All animals are equal but some animals are more equal than others." And the Double Standard is alive and well in our hobby.

□□□

Nelson Heintzman (New York, USA): "I hope you won't consider me presumptuous, but please allow me to congratulate you on settling that controversy of yours "out of court", thus leaving it out of the pages of EE. When I read last month that yo-u planned on raking up out of the past (7 months) some matter which you felt had to be addressed publicly by you, I did feel a momentary wave of disappointment. I almost wrote you as MacFarlane did, but, after all, I'm a new subber, we don't have any prior relationship, it is your zine to do with what you want, it was really none of my business, etc... So I said nothing. But I am glad that the matter has been settled. I've been involved in the PBM hobby just about a year now, so I caught some of what was happening over the winter, although I apparently subbed to zines that only touched upon it in passing. I say this because my awareness of your difficulties was quite minimal, believe me, until I was fortunate enough to become a possessor of all your back issues except for the first 3.

This rare opportunity allowed me to sit down and read month after month after month what was happening in your own words (your perspective of course). And, I was able to do this within the space of hours, so I was afforded a concentrated exposure to your problems as you saw them.

Without getting into the question of whether you overreacted or not, what is quite clear is that your forceful way of dealing with those events was quite, quite successful. By the beginning of summer, my reading of your zine plus countless other back issues of zines which later I obtained, all seemed to quite clearly indicate that much of this stuff was now a non-issue and that various people were adopting a hands-off policy as regarded you. The flack had stopped. That's why I felt a bit sad that you were resurrecting what seemed to be dead and buried. However, there was enough morbid curiosity in me to patiently await what was to be offered. I am happy to report, however, that I felt relieved to read that the matter was indeed now closed.

Your zine has so much to offer to every taste that it really seems above all this hobby feuding that goes on between a small, select group of pubbers. With all the polls going on, why aren't more pubbers trying to find out from the mass of hobby players how they really feel about reading all this stuff? I think Linsey put that question in one of his questionnaires, but I haven't seen any



"others, I don't believe. Being human, probably some of this does indeed titillate and intrigue most of the hobby audience at least some of the time, but after a while, all these hobby mini-soap operas do become tiresome. Still hard evidence would either verify or contradict my impression."

□ When I first entered the hobby, I made friends. Later ^{some of} these friends got into a vicious feud. It was so bad that you literally couldn't open a zine without reading more attacks between them. I was one of the mediators. I was so good on giving advice saying things like: "No one believes this about you" and "No one wants to read this."

But, that was before I became one of the victims of an attack. It radically changes your perspective and I responded and put my point across. I gave full presentation to my detractors (This is Martin, Baumeister and Stafford) and truly thought that would be the end of that since everything they said had been so stupid and they hadn't the slightest evidence to back up anything they said. And I had supplied chapter and verse, zine and issue number to support what I was saying.

What I hadn't reckoned on, and still don't see why they did it, was ^{some of} my friends leaping to the defense of these guys and criticizing only me. It was just like criticizing the Americans for attacking Japan without even mentioning Pearl Harbor. And when they attacked me, they didn't present the full story of these events as I had done in EE, thus their readers, hundreds of people, were getting a distorted story. When this grew to 6 zines and 3 subzines, you can see my difficulty. There was no way I could respond to 9 or 10 people who were, as Rod said, trying to goad me. Besides their own publications, they wrote to other letter columns. I received abusive letters and unpleasant phone calls.

To these 6 zines and 3 subzines, I didn't reply at all (except for the Brawner editorial). They couldn't believe this so then I was accused of mounting a letter campaign and/or phone campaign to ruin their reputations! I could only wait until they stopped abusing me in their zines and subzines, and approached me wanting to be friends again as most of them did.

I thought I would enjoy it if they got into a feud and ripped each other apart as they had done to me, some of their own medicine as it were. ^{But} I recently saw this in another zine and it sickened me and I wrote in about it.

The painful truth, in this hobby, is that controversy and smears are part and parcel. I dealt with the attacks on me with extensive ^{coverage} in EE. (So much so, that John Michalski who adores reading about feuds, called the Coughlan-Martin feud boring and wished it would just go away. Perhaps that's the way to handle feuds, eh?). I probably would do the same thing again, if I had it to do over, in the case of Martin, Stafford and Baumeister. I have never put out an issue of this zine that I have been ashamed of. Any future readers who come across the EEs that Nelson refers to, and then checks out the 6 zines and 3 ~~subzines~~ will see who needs to be ashamed. I don't fear the comparison.

I have printed these two letters, by Nelson and Rich, not to revive any feuds but to let people know that feuds leave scars long after the people have become friends again. Please watch what you print and what you say about another person. If you don't want it done to you, don't do it to someone else.

But, if you do do it to someone else, don't be surprised if they answer you back. I know now that I won't ever keep quiet, as I did last winter in regard to the 6 zines and 3 subzines, when the cheap-shot artists go after me. I've turned the other cheek.

□□□

John Michalski (Oklahoma, USA): "I'll be in Wichita on an audit when you read this. Wow. Flushing next?"

□ Yes, if the information I've received has been correct which is that Bob Olsen will leave his Wichita residence and go to Flushing, New York around Thanksgiving. I hope you throw the book at him (John is an auditor), Lord knows he's lived high off the hog from that oil money long enough without getting caught!

□□□

John Schuler (California, USA): "What have you been up to, Gary? Are you a Tennessee Son? Are you old? Middle-aged? A nineteen-year-old genius? Reborn? Recently unearthed? Gemini? Scorpio? Sleazy? A renegade? Always wanted to visit Wisconsin??" □ Mr. Schuler of California, you sure ask a lot of questions! (39)

HANDELSMAN FREAKY FABLES

Tripping
hither,
tripping
thither

IN THE COURSE OF HIS LONG HOMEWARD VOYAGE, ODYSSEUS SENT OUT A PATROL IN THE LAND OF THE LOTUS-EATERS.

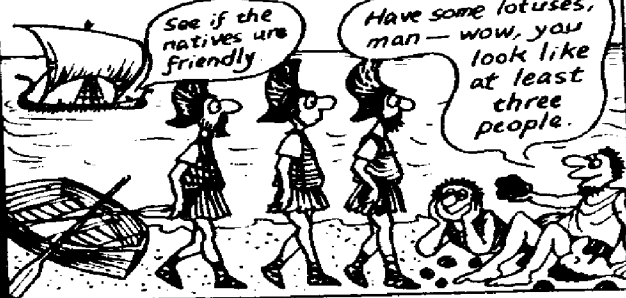

Well? Are they friendly?

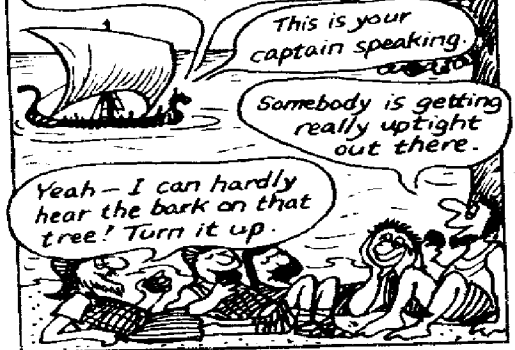

AT THE ISLAND RULED BY CIRCE, ANOTHER ADVANCE PARTY WAS SENT OUT.



What have you done to my men, madam? I insist that you debrief them at once.

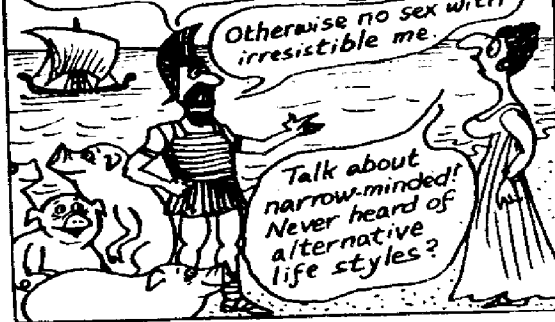

APPROACHING THE SIREN SISTERS' ROCK, ODYSSEUS TOOK THE PRECAUTION OF PLUGGING HIS SAILORS' EARS.



If the way you hold your bouzouki - the way you sip your retsina...

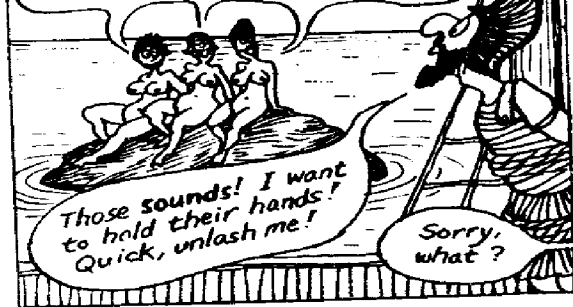

Charybdis sucks, but how does Scylla grab you?

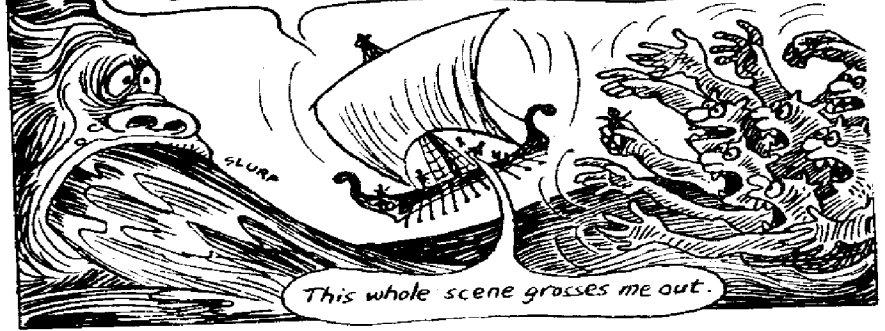

A THUNDERBOLT FROM ZEUS WRECKED THE SHIP.

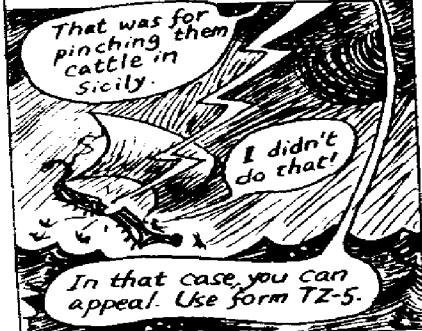

ODYSSEUS WASHED UP ON THE SHORE OF THE ISLE WHERE DWELT THE NYMPH CALYPSO.



BUT HE FINALLY DID GO HOME.



MORAL: I don't know what you think, but Freud and I suspect that a man who takes ten years over it is not terribly desperate to go home.

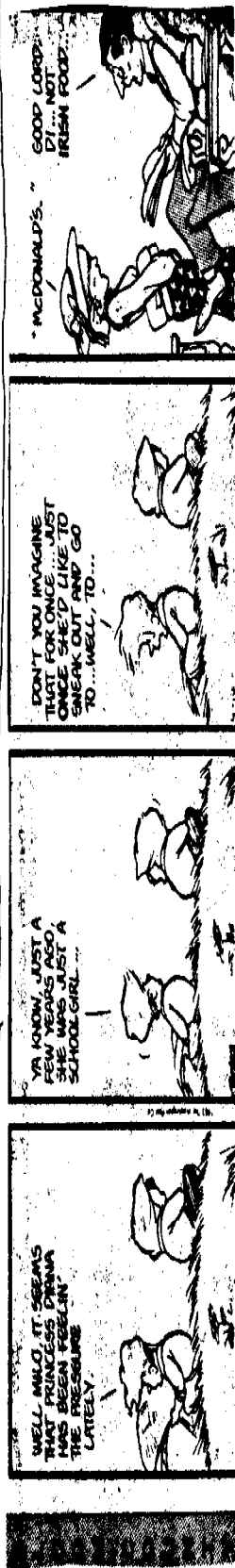
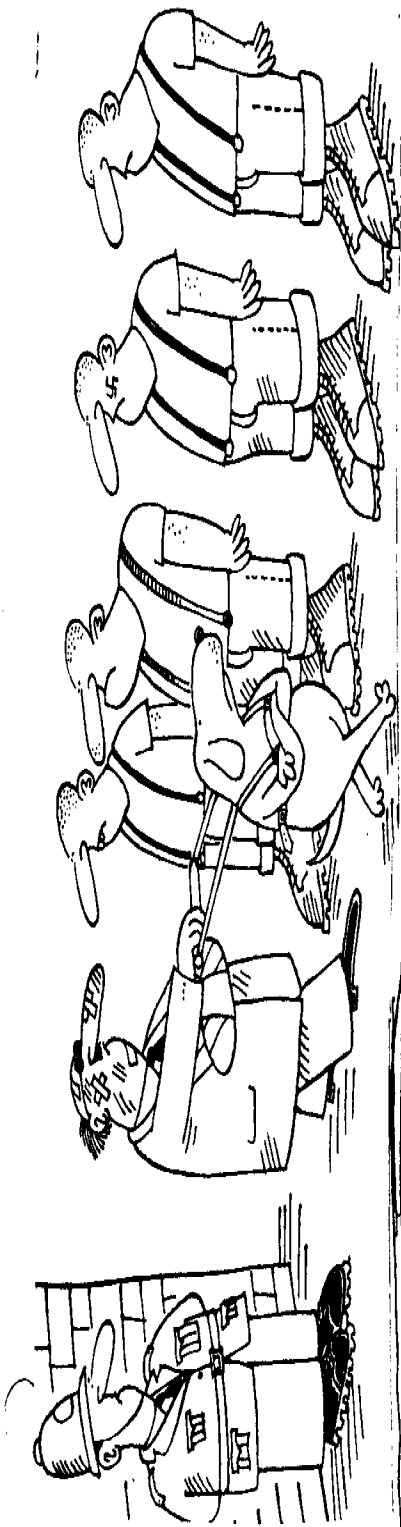

"WELL, MILLO, IT SEEMS THAT PRINCESS DIANNA HAS BEEN FEELIN' THE PRESSURE LATELY."

"YEA KNOW, JUST A FEW YEARS AGO, SHE WAS JUST A SCHOOLGIRL..."

"DON'T YOU IMAGINE THAT FOR ONCE... JUST ONCE SHE'D LIKE TO SNEAK OUT AND GO TO... WELL, TO..."

"MCDONALD'S." "GOOD LORD, DI... NOT IRISH FOOD."



"Now tell me—what's it like being a sex-symbol?"



"We figure his nose got stuck in the keys, then he beat his brains out trying to type 'help'."

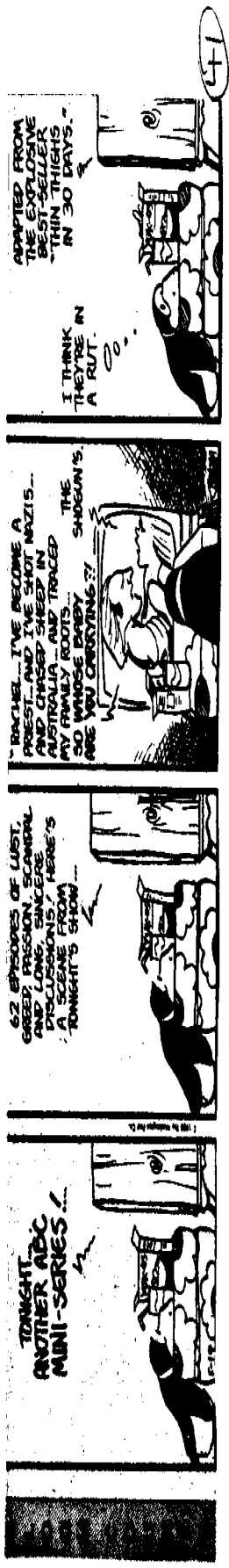

"TODAY, ANOTHER ABC MINI-SERIES..."

"62 EPISODES OF JUST, GEEZ, PASSION SCREAM AND LONG SINCERE DISCUSSIONS, HERE'S A SCENE FROM TONIGHT'S SHOW..."

"RACHEL... I'VE BECOME A PORN STAR... I'VE TRACED MY FAMILY ROOTS... THE SO WHOLE BABY SHOGUN'S ARE YOU CRYSTALING?!"

"ADAPTED FROM THE EXPLOSIVE PORN THIGHS IN 30 DAYS." "I THINK THEY'RE IN A RUT."

THE BEHOLDER #16

MFP/EE

This is the 14 October 1983 issue of The Beholder, a subzine devoted to the discussion of topics related to the postal Diplomacy hobby, and edited by John Kelley, 209 McMahon Hall GO-10, U. of Washington, Seattle, WA 98195 USA, in cooperation with Gary Coughlan. Letters are welcomed and usually answered promptly.

The oldtimers may recognize me and TB; for those who don't, TB was once a full-fledged gamezine in its own right. It folded in 1979 (if I remember correctly) with issue #15, but I always felt I'd back some day, some way. This intention (threat?) has now come true. Now, please permit me to introduce myself; this is pertinent even to those who know/knew me well as I have changed a lot since 1979.

At present I am 20 (as of the 12th) years old, a junior studying ancient history at Washington. I stand 5'9" and weigh 195 lbs. clothed; I have light brown hair and green eyes, with a wide Irish grin that I like to think is devil-may-care and friendly. As a high school publisher, I was a different person; fanatically conservative, loudmouthed, childish, thin-skinned, and fatalistic. I had no concept of the word 'optimism'. The years have done their work; now I am tolerantly and moderately conservative, softer-spoken, somewhat more mature, and happy and optimistic.

Why publish a subzine? Why not do one of my own? I've got a ditto machine, and I can write letters. Those won't fry the bacon, though; I'm too lazy to do my own zine and since I became more sedate, no one will print my letters (too boring, I guess). My ego is colossal enough that I will go to any lengths to have people listen to my opinions. In fact, I'd even start a subzine if it came down to it. So here I am. I hope you like it; whether you do or not, I am open to your opinion, so please express it.

The reason I wanted to write for EE is because I don't like the letter column format but perversely enough, wanted to participate in it so I decided to ask for a spot where I could do the ratchet-jaw trick without being interrupted. I am very grateful to Gary for letting me do this. (Try not to vomit, Rebel!)

I think I'll kid Gary by calling him 'Reb'. Cackle.
Bob Albrecht, how're ya doing?

I'm especially looking forward to meeting some of the European subscribers, since I intend to visit that continent someday and am very interested in other countries.

John Michalski is a riot. Let's hear it for conservatives who mix a sense of humour with good logic.

Got to meet Cathy Cunning recently. She's really nice; we went over to Terry Tallman's, so I met him too. He's pretty sarcastic, but he's intelligent and makes his points well. Good sense of humour. So now the Northwest Clique is in full swing, right?

Here's an opinion for people to hop on. Why is everybody and his pet piranha criticizing the resigned James Watt's environmental policies? Pull your heads out, please, people. I freely admit my ignorance of environmental science and economics. Many people think that you don't need to know anything about a subject to spout off intelligently on it; this is not the case. Very few (maybe 5% of his critics) know enough about the issues to be mouthing off. If people are ignorant, why don't they admit it and stick to topics they're competent to discuss? Now we can fault Watt for a total lack of tact; indeed, it doesn't take much to see that his sense of public relations is incredibly bad. But that's an entirely different thing to discuss. Folks, if you don't know, maybe you

would be well advised to hold your fire. No, this topic (Watt) has-
n't been an issue in EE; it's an American domestic issue, and has
been very heated.

Western Europe/NATO? I feel that some give-and-take is ne-
cessary on both sides. Americans need to listen closely to their
allies, a thing which they haven't always done. Europeans, in turn,
need to realize where we're coming from: we station our people in
other countries for their protection, and that's a sacrifice. I
can't help but feel that if both camps try harder to understand each
other's concerns things would get better. When I get stationed in
West Germany, I plan to speak German in the presence of Germans,
even if it means going around with a little phrasebook; in turn, I
hope that the Germans will treat me as an ally who is here for their
benefit. Sounds reasonable to me. Hell, it's not my country, al-
though the German blood runs nearly true in me. Same story anywhere
I go; if necessary, I'll speak some form of Chinese to the Chinese,
with the understanding that they will speak English to me in the
USA. Fair enough, NATO?

I don't like hobby organizations and encourage general chaos
in postal Diplomacy. If someone wants to provide a service, well
and good; but let's not institutionalize it and anoint a successor.
If no one wants a job, piss on it. We can do without it.

Until next time--

JK²

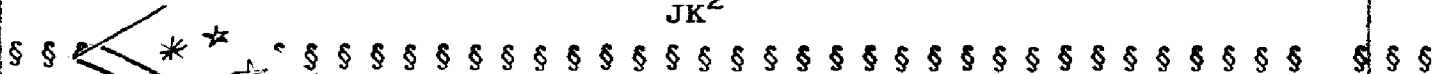

FOCUS ON FAKES!

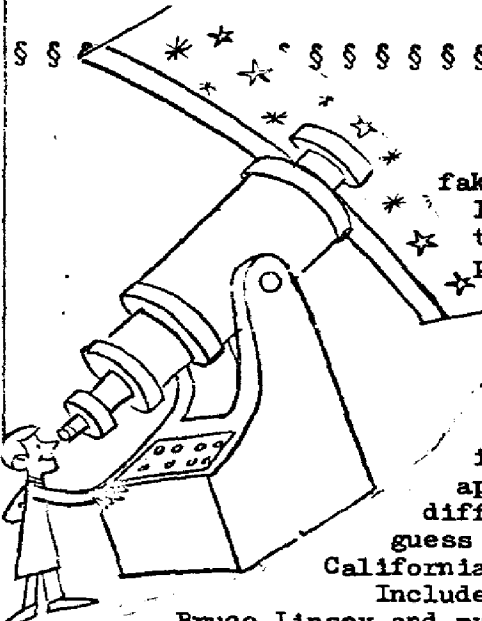

This department of EE gives publicity to any
fake or spoof of a zine that finds its way into my mail.
I have faked 3 zines and they were hardly noted by
the hobby press so I resolved that when I became a
pubber that I would make sure any faker got feedback
on something which takes great effort and usually
provides a lot of fun to the hobby. I received
a fake zine this month.

This was called Ya'all and was labeled as
Issue #5, and so requires some explanation. Since
before EE began as a zine, a zine called Y'all, which
is supposedly by me, and full of Southern dialect, has
appeared at odd intervals and have been done by several
different persons. #5 is by yet another person (my own
guess is Mike Mazzer). It was mailed from Los Angeles,
California and was 8 pages in length.

Included in Ya'all #5 was the announcement that Dick Martin,
Bruce Linsey and myself (the 3 co-winners of Terry Tallman's "Most
Obnoxious Hobby Member") would be starting an appropriately named zine
called Rrrrrrrrrrrrusnak! Another item was about all types of polls: How Steve
Langley should wear his hair, Bob Olsen's "Best Shasta Diet Drink" poll, is Eric
Wzog and orc or an elf, a Bruce Linsey house rule poll (send him any he doesn't
already have) and the James Briggs Poll Poll about your favorite polls.

The issue also had Frauke teaching me the wrong German words for when I went
to Europe and it featured a letter column with letters from Mark Luedi, Mark
Berch (every word was misspelled) and Mike Mazzer.

There was also a subzine, supposedly by my cow, Elsie called Udder Nonsense.
I really enjoyed this issue of Ya'all and if any of you are planning on doing a
fake or a spoof-zine of any type, please send me a copy and I'll review it here
in EE. And, as Elsie said in Udder Nonsense, "and a big "MOOOOOOOOOOO" to ya'all
out there!"

43

GARY L. COUGHLAN
4614 Martha Cole Lane
Memphis, Tennessee 38118
UNITED STATES OF AMERICA

Robert Millikan



FIRST CLASS MAIL!!!!

FIRST CLASS MAIL!!!!

Larry Peery (T)
P.O. Box 8416
San Diego, California 92102

117

FIRST CLASS MAIL

FIRST CLASS MAIL

Your sub expires with issue (see label)